

# **T·VERTER N2 Series**

**Adjustable Frequency**

**A.C. Motor Drive**

---



**N2-220V**

**0.4~22KW  
( 1.2~33.2KVA )**

**N2-440V**

**0.75~22KW  
( 1.7~36.6KVA )**

---

# Operations Manual

## Table of Contents

Foreword.....	1
Precautions for Operation .....	2
Operational Environment .....	6
General Introduction .....	7
Specifications.....	9
Wiring Rules.....	11
Keypad Operations .....	21
Parameter List.....	22
Functional Description .....	30
Failure Codes.....	60
Maintenance Section .....	65
Filters .....	66
Dimensions .....	70
Braking Resisters & Reactors .....	74
Trouble Shooting.....	<b>78</b>

## Foreword

To fully employ all functions of this T-verter and to ensure the safety for its users, please read through this operations manual in detail. Should you have any further questions, please feel free to contact your local distributor or regional representative.

### **PLEASE READ AND UNDERSTAND THIS MANUAL BEFORE**

#### **OPERATING THIS T-VERTER**

The T-verter is a power electronic device. For safety reasons, please read carefully those paragraphs with “WARNING” or “CAUTION” symbols. They are important safety precautions to be aware of while transporting, installation, operating or examining the T-verter. Please follow these precautions to ensure your safety.

#### **WARNING**

Personnel injury may be resulted by improper operation.

#### **CAUTION**

The T-verter or mechanical system may be damaged by improper operation.

#### **WARNING**

- Do not touch the PCB or components on the PCB right after turning off the power before the charging indicator went off.
- Do not attempt to wire circuitry while power is on. Do not attempt to examine the components and signals on the PCB while T-verter operating.
- Do not attempt to disassemble or modify internal circuitry, wiring, or components of the T-verter.
- The grounding terminal of the T-verter must be grounded properly (200V class: Ground to 100 or less, 400V class: Ground to 10 or less).
- This is a product of the restricted sales distribution class according to EN61800-3.

In a domestic environment this product may cause radio interference in which case the user may be required to take adequate measures.

#### **CAUTION**

- Do not attempt to perform dielectric strength test to internal components of the T-verter. There are sensitive semiconductor-devices vulnerable to high voltage in the T-verter.
- Do not connect the output terminals: T1 (U), T2 (V), and T3 (W) to AC power input
- The CMOS IC on the primary PCB of the T-verter is vulnerable to static electrical charges. Do not contact the primary PCB of the T-verter.

## Precautions for operation

### Examination before installation

Every T-verter has been fully tested and examined before shipment. Please carry out the following examination procedures after unpacking your T-verter.

- Check to see if the model number of the T-verter matches the model number of the T-verter that you ordered.
- Check to see whether any damage occurred to the T-verter during shipment. Do not connect the T-verter to the power supply if there is any sign of damage.

### Before turning ON power

#### CAUTION

Choose the appropriate power source with correct voltage settings for the input voltage specification of the T-verter.

#### WARNING

Special care must be taken while wiring the primary circuitry terminals. The (L1) (L2) and (L3) terminals must be connected to the input power source and must not be mistakenly connected to (T1) (T2) or (T3) output terminals. This may damage the T-verter when the power is turned on.

#### CAUTION

- Do not attempt to transport the T-verter by the front of the cover. Securely hold the T-verter by the heat-sink mounting chassis to prevent the T-verter from falling, this may cause personnel injury or damage to the T-verter itself.
- Install the T-verter onto a firm metal base plate or another non-flammable type material. Do not install the T-verter onto or nearby any flammable material.
- An additional cooling fan may need to be installed if several T-verters are installed into one control panel. The inside temperature inside an enclosed panel should be below 40 degrees to avoid overheating.
- Turn off the power supply before proceeding to remove or perform any work on any panel. Carry out installation procedures according to instructions given in order to avoid a situation resulting in an operational malfunction.
- This product is not provided with over speed protection.
- Only intended for use in a pollution degree 2 macro environment or equivalent

## When power is applied

### WARNING

Do not attempt to install or remove input or out put connectors of T-verter when the power supply is turned on. Otherwise, the T-verter may be damaged due to the surge peak caused by the insertion or removal.

## Under Operation

### WARNING

- Do not use a separate device to switch ON or OFF motor during operation. Otherwise, the T-verter may experience an over-current breakdown.
- When momentary power loss is longer than 2 seconds (the large of horse power, the longer of time), the inverter does not have enough storage power to control the circuit; Therefore, when power is regenerated, the operation of the inverter is based on the setup of Fn\_10/16 and the condition of external switch, this is considered to be 「restart」 in the following paragraphs.
- When the momentary power loss is short, the inverter still has enough storage power to control the circuit; therefore, when power is regenerated, the inverter will automatically start operation again depends on the setup of Fn\_31/32.
- When restart the inverter, the operation of the inverter is based on the setup of Fn\_10 and the condition of external switch (FWD/REV button). Attention: the restart operation is irrelevant with Fn\_31/32/34/35.
  - (1) When Fn\_10=0, the inverter will not start after restart.
  - (2) When Fn\_10=1 and the external switch (FWD/REV button) is OFF, the inverter will not start after restart.
  - (3) When Fn\_10=1, the external switch (FWD/REV button) is ON, and Fn16=XXX0, the inverter will start automatically after restart. Attention: Base on safety reason, please turn off the external switch (FWD/REV button) after power loss to avoid possible damage to the machine and the human body after sudden regeneration of power.

### WARNING

- Do not remove the front cover of the T-verter when the power is ON to avoid personnel injury caused by electrical shock.
- When the automatic restart function is enabled, the motor and machinery will be restarted automatically.

**⚠ CAUTION**

- Do not touch the heat-sink base during operation.
- The T-verter can be easily operated from a low-speed to high-speed range. Please reconfirm the operating range of motor and the machinery you are controlling.
- Do not examine the signals on the PCB of the T-verter when it is under operation.
- All T-verters are properly adjusted and set before delivery.

**⚠ CAUTION**

Do not proceed with disassembly or examination procedure before ensuring that the power is off and the Power LED extinguished.

**When performing an examination or maintenance**

**⚠ CAUTION**

The environment temperature should be within  $-10^{\circ}\text{C} \sim +40^{\circ}\text{C}$  and humidity under 95% RH without condensing. Besides, the T-verter should be free from water dripping or metal dust.

**Others**

**⚠ WARNING**

Never modify the product.

Failure to observe this warning can result in an electrical shock or personal injury and will invalidate the guarantee.

## Taking Precautions:

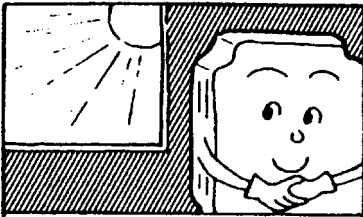

Avoid any direct sunlight

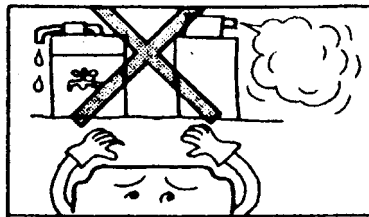

Keep away from corrosive gas or liquid

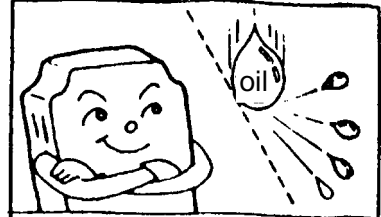

Keep away from oil grease and gas

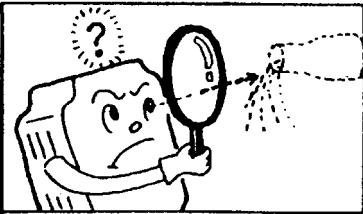

Keep away from salty environments

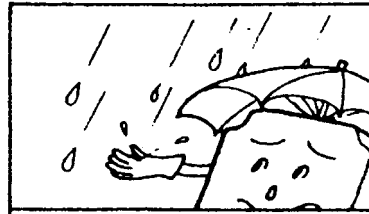

Keep away from rain or where dripping water may get into the T-verter

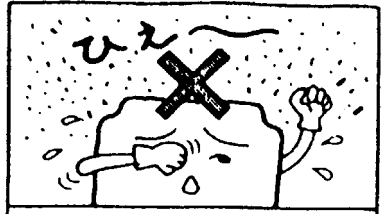

Avoid metal dust and dusty environments

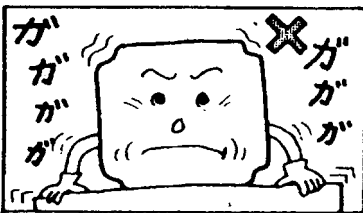

Avoid massive vibration

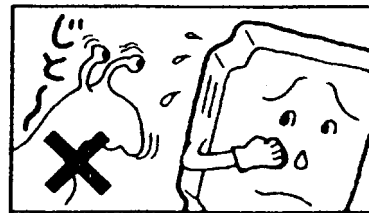

Avoid excessive direct heat

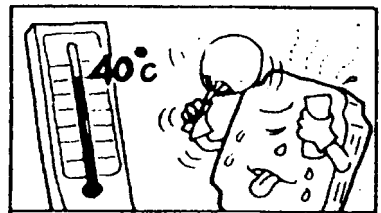

Avoid where environmental temperatures are too high

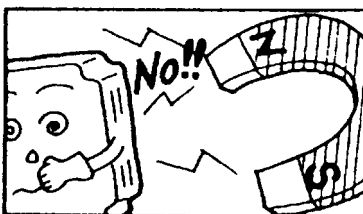

Keep away from high electrical-magnetic waves or ultra-high waves.

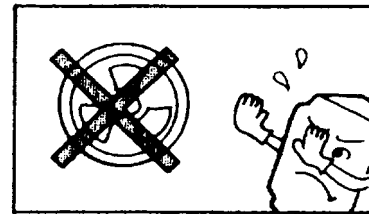

Keep away from radioactive matter

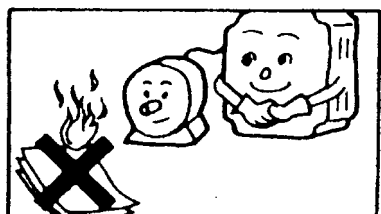

Keep away from flammable material

## Operational Environment

The installation site of the T-verter is very important. It relates directly to the functionality and the life span of your T-verter. Please carefully choose the installation site to meet the following requirements:

- Mount the unit vertically
- Environment temperature:  $-10^{\circ}\text{C} \sim +40^{\circ}\text{C}$ (with cover removed:  $-10^{\circ}\text{C} \sim +50^{\circ}\text{C}$ )
- Avoid placing close to any heating equipment
- Avoid water dripping or humid environment
- Avoid direct sunlight
- Avoid oil or salty corrosive gas
- Avoid contacting corrosive liquid or gas
- Prevent foreign dusts, flocks, or metal scraps from entering interior
- Avoid electric-magnetic interference (soldering or power machinery)
- Avoid vibration, if vibration cannot be avoided, an anti-rattle mounting device should be installed to reduce vibration.
- If the T-verter is installed in an enclosed control panel, please add additional cooling using an external fan. This will allow additional airflow and cooling.
- Placement of external fans should be directly over the top of the T-verter.
- For proper Installation of the T-verter you must place the front side of the T-verter facing front and the top of the T-verter in the up direction for better heat dissipation.
- Installation must be compliant to the following requirements.

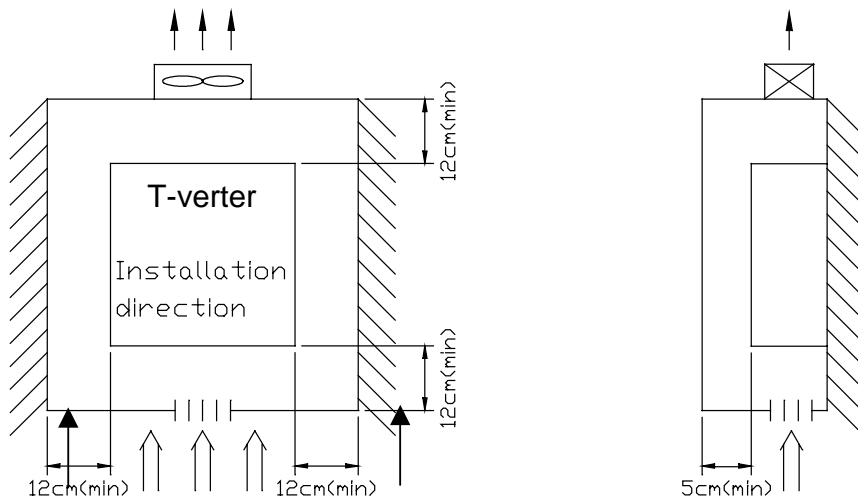

Ventilation- $10^{\circ}\text{C} \sim +40^{\circ}\text{C}$   
& Installation Direction  
Front & Side Views



## **General Introduction:**

### **General**

T-verter N2 series is a high performance general-purpose inverter that incorporates a high efficiency Pulse Width Modulated (PWM) design and advanced IGBT technology. The output closely approximates a sinusoidal current waveform to allow variable speed control of any conventional squirrel cage induction motor.

### **Receiving**

This unit has been put through demanding tests at the factory prior to shipment.

Before unpacking please check the following:

1. Identify the description of the product found on the label with your purchase order.
2. Inspect for transport damage (serious damage of carton may lead to damage of the unit)

Please check the followings after unpacking:

- a. Check if the specifications (current & voltage) on the front cover match to your application requirement.
- b. Check all the electrical connections and screws.
- c. Verify that there is no visible damage to any of the components.

If any part of the T-verter or the box it came in is damaged, please notify the carrier and your distributor immediately.

# Installation:

## Location

Picking the proper installation location for the T-verter is imperative in order to achieve the maximum specified performance & operation from the Drive. The T-verter should always be installed in areas where the following conditions exist.

- \* Good ambient operating temperature:  
-10 to 40 (14 to 104 F), -10 to 50 (14 to 122 F) with cover removed
- \* IP Rating: IP 20 for all models. If the T-verter is placed in another enclosure, please provide addition cooling using an external fan.
- \* Protected from rain & moisture.
- \* Shielded from direct sunshine.
- \* Free from metallic particles and corrosive gas.
- \* Free from excessive vibration. (Below 0.5G)

## Positioning

For effective ventilation and maintenance purposes, sufficient clearance (as shown in figure 2.1) around the T-verter is necessary. The T-verter must be installed with heat sink ribs oriented vertically.

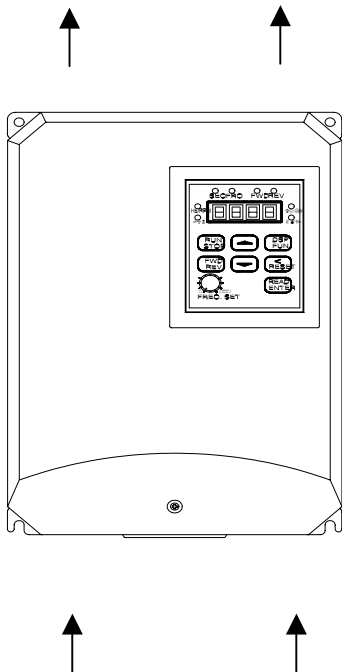

- Allow 12cm clearance on both sides of the enclosure
- Be sure to allow the air to move freely through the heat sink area.

## Basic Specification:

### Mode No. Identification

<b><u>N2</u></b>	-	<b><u>2</u></b>		<b><u>01</u></b>		<b><u>H</u></b>		<b><u>3</u></b>		<b><u>N4</u></b>
Series	Input Voltage	Capacity	Specification	Phase of input power	Enclosure					
	2 : 200V Class	P5 : 0.5Hp	M : Standard type	Blank : 1/3 phase	Blank : IP20					
	4 : 400V Class	~	<b>H : Advanced type</b>	3 : 3 phase	N4 : IP65(NEMA4)					
		30 : 30Hp								

### 1/ 3 Phase 200-240 Volts

<b>N2-      —xxx *1</b>	<b>2P5</b>	<b>201</b>	<b>202</b>	<b>203</b>	<b>205</b>	<b>208</b>	<b>210</b>	<b>215</b>	<b>220</b>	<b>230</b>
Horse Power	1/2	1	2	3	5	7.5	10	15	20	30
Rated Motor KW	0.4	0.75	1.5	2.2	3.7	5.5	7.5	11	15	22
Rated Current (A)	3.1	4.5	7.5	10.5	17.5	26	35	49	64	87
Output (KVA)	1.2	1.7	2.9	4.0	6.7	9.9	13.3	18.7	24.4	33.2
Input Voltage <b>Max.</b>	(1 / 3 Phase) (200~240 Volts +-10%) (50/60Hz +-5%) (5 h.p. & above 3 Phase Only)									
Output Voltage <b>Max.</b>	3 Phase 200 ~ 240 (proportional to input voltage)									
IP20 Weight (Kg)	1.4	1.4	2.5	4.0	4.0	6.8	7.1	12.3	12.5	13.8
Power Loss Ride Through (s)	1	1	2	2	2	2	2	2	2	2

### 3 Phase 380 ~ 480 Volts

<b>N2-      -xxx *1</b>	<b>401</b>	<b>402</b>	<b>403</b>	<b>405</b>	<b>408</b>	<b>410</b>	<b>415</b>	<b>420</b>	<b>430</b>
Horse Power	1	2	3	5	7.5	10	15	20	30
Rated Motor KW	0.75	1.5	2.2	3.7	5.5	7.5	11	15	22
Rated Current (A)	2.3	3.8	5.2	8.8	13	17.5	25	32	48
Output (KVA)	1.7	2.9	4.0	6.7	9.9	13.3	19.1	24.4	36.6
Input Voltage <b>Max.</b>	( 3 Phase 380 ~ 480 Volts +- 10%) (50/60Hz +- 5%)								
Output Voltage <b>Max.</b>	3 Phase 380 ~ 480 Volts (proportional to input voltage)								
IP20 Weight (Kg)	2.4	2.5	3.8	4.0	7.0	7.3	12.3	12.5	13.5
Power Loss Ride Through (s)	1	1	2	2	2	2	2	2	2

Note \*1 (IP65) NEMA4 enclosure type only available for 0.5 ~ 10HP & below

## Functional Specification:

Control Characteristics	Carrier frequency	1 - 12 K	
	Frequency Control Range	0.1 – 400 Hz	
	Frequency Accuracy	Digital: 0.01% (-10 ~ 40 °C); Analog: 0.4% (25+-10 °C)	
	Frequency Resolution	0.01 Hz with computer or PLC control, 0.1 Hz with keypad control when freq. above 100 Hz	
	Frequency Setting Signal	(0-5VDC) (0-10VDC) (4-20mA) (0-20mA)	
	Accel / Decel Time	0.1-3600 SEC with (2) S-curves	
	Braking Torque	About 20% (built-in Braking transistor)	
	V/F Pattern	18 patterns, one curve programmable	
Protection Function	Instantaneous Over Current	Approx. 200% rated current	
	Overload	T-verter: 150% / 1 minute	
	Motor Overload Protection	Electronic thermal overload relay	
	Over voltage	200V series: (DC bus voltage exceeds 427V) 400v series: (DC bus voltage exceeds 854V)	
	Under voltage	200V series: (DC bus voltage drops < 200V) 400v series: (DC bus voltage drops < 400V)	
	Momentary Power Loss	0~2 seconds: The T-verter can be restarted using the speed search feature	
	Heat Sink Fin Overheat	Protected by thermister	
	Ground Fault	Electronic circuit protection	
Operation Conditions	Input Signal	Operation signals	Forward/Reverse operation, by keypad or hardwire contact, multiple individual commands
		Reset	Released protection while the protective function is operating
		Multifunction Input	Refer to function illustration in Fn_56
	Output Signal	Multifunction Output	Refer to function illustration in Fn_61
		Fault output	250VAC 1A, 30VDC 1A or less
	Built-in Function	Frequency reference bias/gain; up/lower limit; manual torque boost; frequency meter calibrating gain; auto restart attempt; skip frequency; S-curve ACCEL/DECEL; Carrier frequency adjust.(1-12KHz) Communication link function	
	Digital operator monitor	Frequency command, output frequency, speed, output current, output voltage, P-N bus voltage, rotating direction	
	Analog Output Monitor	Analog output (0-10V), possible to select output frequency & setting freq. & output voltage & P-N bus voltage	
Environmental	Location	Indoor (protected from corrosive gas and dust)	
	Ambient Temperature	-10 degrees ~ 40 degrees @ 50 degrees with cover removed	
	Humidity	0-95%(non condensing)	
	Vibration	0.5G	
Enclosure	IP20 / IP65 (NEMA4)		
EMC	EN50081-1, EN50082-2 (with optional filter)		
LVD	EN50178		
UL	UL 508C		

- N2-205 and above capacity are not CE complied

## Wiring Rules:

### 1. Notice for wiring

- A. Screwdriver torque: Connect cables with a screwdriver or other tools and follow the torque listed below.

Securing torque			
Horsepower	Power source <b>Max.</b>	Nominal torque for TM1 terminal	
0.5/1/2/3	200 – <b>240V</b>	1.33 lbs.-ft	16 lbs.-in
1/2	380 – <b>480V</b>		
5/7.5/10	200 – <b>240V</b>	1.15 lbs.-ft	13.8 lbs.-in
3/5/7.5/10	380 – <b>480V</b>		
15/20/25/30	200 – <b>240V</b>	1.83 lbs.-ft	22 lbs.-in
15/20/25/30	380 – <b>480V</b>		

B. Power wires

Power wires are wires connected to L1, L2, L3, T1, T2, T3, P and R. Choose wires in accordance with the following criteria:

- (1) Use wires with copper cores only. Decide diameters of wires based on working conditions at 105°C.
- (2) For nominal voltage of wires, the minimum voltage of **240VAC** type is 300V, and **480VAC** type is 600V.

C. Control wire

Control wire is connected to TM2 control terminal. Choose the wire in accordance with the following criteria:

- (1) Use wires with copper cores only. Decide the diameter of the wire based on working conditions at 105 .
- (2) For nominal voltage of wires, the minimum voltage of **240VAC** type is 300V, and **480VAC** type is 600V.
- (3) To avoid noise interference, do not route the control wire in the same conduit with power wires and motor wires.

D. Nominal electrical specifications of the terminal base: The following are nominal values of TM1:

Horsepower	Power source <b>Max.</b>	Volts	Amps
0.5/1/2/3	200 – <b>240V</b>	300	20
1/2	380 – <b>480V</b>		
5/7.5/10	200 – <b>240V</b>	600	40
3/5/7.5/10	380 – <b>480V</b>		
15/20	200 – <b>240V</b>	600	60
15/20/25/30	380 – <b>480V</b>		
25/30	200 – <b>240V</b>	600	100

Note: Nominal values of input and output signals (TM2) – follow the specifications of class 2 wiring.

## 2. Fuse types

To protect the inverter most effectively, use fuses with current-restraint function.

Horsepower	Power source <b>Max.</b>	Rated fuse specifications
2	200 – <b>240V</b>	15A, 600VAC, 100KA, I.R.
3		20A, 600VAC, 100KA, I.R.
5		30A, 600VAC, 100KA, I.R.
7.5/10		60A, 600VAC, 100KA, I.R.
15/20		100A, 600VAC, 100KA, I.R.
25/30		150A, 600VAC, 100KA, I.R.
1		380 – <b>480V</b>
2	10A, 600VAC, 100KA, I.R.	
3	15A, 600VAC, 100KA, I.R.	
5	20A, 600VAC, 100KA, I.R.	
7.5/10	40A, 600VAC, 100KA, I.R.	
15/20	70A, 600VAC, 100KA, I.R.	
25/30	100A, 600VAC, 100KA, I.R.	

- 3. Use the circuit properly, and the carrying current does not exceed 5000 Arms. The maximum output voltage is 240V for 200 – 240V models when carrying current is below 5000 Arms.**
- 4. We cannot guarantee safety for over-speed or similar situations. Do not connect the inverter to a controller or similar devices with current restraint function.**
- 5. Notice:**
  - 5.1 To avoid shock hazard, do not touch any electrical component when the power is applied or just after the power plug is unplugged.
  - 5.2 Do not perform wiring on the inverter while it is still electrified. Disregard of this notice can cause serious injure or death to persons.
- 6. This product is designed to be used under class 2 contaminated environment or similar environments.**

## Applicable magnetic contactor and wires

Molded-case circuit breaker/magnetic contactor

- Our bears no responsibility to service for failures caused by the following conditions:
  - (1) A molded-case circuit breaker is not installed, or an improper or overrated breaker is used, between the power source and the inverter.
  - (2) A magnetic contactor, a phase capacitor, or a burst absorber is connected between the inverter and the motor.

Inverter model	N2-2P5	N2-201	N2-202	N2-203	N2-205	N2-208	N2-210	N2-215 N2-220	N2-230
MCCB made by Teco	TO-50E 20A	TO-50E 20A	TO-50E 30A	TO-50E 30A	TO-50E 30A	TO-50E 50A	TO-100S 60A	TO-100S 100A	TO-225S 175A
MC made by Teco	CN-11		CN-16	CN-18	CN-25	CN-50	CN-65	CN-100	CN-100
Main circuit terminals (TM1)	Wire gauge 2.0 mm <sup>2</sup> Terminal screw M4			Wire gauge 3.5 mm <sup>2</sup> Terminal screw M6		Wire gauge 5.5 mm <sup>2</sup> Terminal screw M6		Wire gauge 14 mm <sup>2</sup> Terminal screw M8	Wire gauge 22 mm <sup>2</sup> Terminal screw M8
Signal terminals (TM2)	Wire gauge 0.75mm <sup>2</sup> (# 18 AWG), terminal screw M3								

Inverter model	N2-401/402/403/405			N2-408	N2-410	N2-415	N2-420	N2-430
MCCB made by Teco	TO-50E 15A			TO-50E 20A	TO-50E 30A	TO-50E 50A	TO-100S 60A	TO-100S 100A
MC made by Teco	CN-11			CN-16	CN-18	CN-25	CN-35	CN-50
Main circuit terminals (TM1)	Wire gauge 2.0mm <sup>2</sup> Terminal screw M4			Wire gauge 3.5mm <sup>2</sup> Terminal screw M4		Wire gauge 5.5mm <sup>2</sup> Terminal screw M6	Wire gauge 8mm <sup>2</sup> Terminal screw M6	Wire gauge 14mm <sup>2</sup> Terminal screw M6
Signal terminals (TM2)	Wire gauge 0.75mm <sup>2</sup> (# 18 AWG), terminal screw M3							

- Use three-phase cage reaction motor with capacity suitable for the inverter.
- When one inverter is used to drive several motors, the total current of all motors running simultaneously must be less than the capacity of the inverter, and each motor has to be equipped with a proper thermal relay.
- Do not add capacitive component, such as a phase capacitor, LC, or RC, between the inverter and the motor.



## Precautions for peripheral applications:

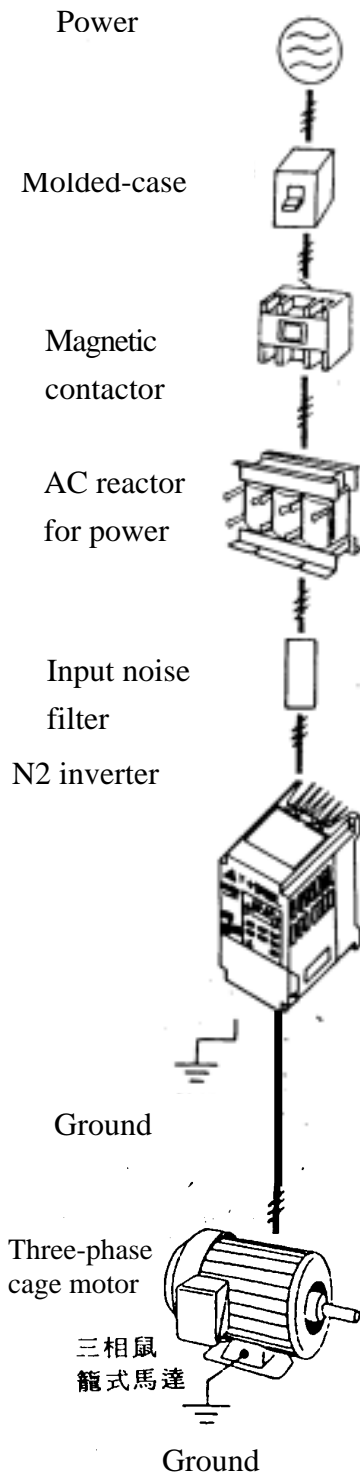

### Power source:

- Make sure the voltage applied is correct to avoid damaging the inverter.
- A molded-case circuit breaker must be installed between the AC source and the inverter.

### Molded-case circuit breaker:

- Use a molded-case circuit breaker that conforms to the rated voltage and current of the inverter to control the power ON/OFF and protect the inverter.
- Do not use the inverter as the switch for run/stop switching.

### Leakage breaker:

- Install a leakage breaker to prevent error operation caused by electric leakage and to protect operators.

### Magnetic contactor:

- Normal operations do not need a magnetic contactor. But a contactor has to be installed when performing functions such as external control and auto restart after power failure, or when using brake controller.
- Do not use the magnetic contactor as the run/stop switch of the inverter.

### Reactor for power improvement:

- When inverters below 200V/400V 15KW are supplied with high capacity (above 600KVA) power source, a reactor can be connected to improve the power performance.

### Input noise filter:

- A filter must be installed when there are inductive load around the inverter.

### Inverter:

- Input power terminals L1, L2, and L3 can be used in any sequence regardless of phases.
- Output terminals T1, T2, and T3 are connected to U, V, and W terminals of the motor. If the motor is reversed while the inverter is forward, just swap any two terminals of T1, T2, and T3.
- To avoid damaging the inverter, do not connect the input terminals T1, T2, and T3 to AC power.

Connect the ground terminal properly. 200V class: Ground to 100 or less, 400V class: Ground to 10 or less.

Make external connections according to the following instruction. Check connections after wiring to make sure all connections are correct. (Do not use the control circuit buzzer to check connections)

(A) Main circuit's wiring must separate from other high voltage or high current power line to avoid noise interference. See figures below.

- The inverter uses dedicated power line

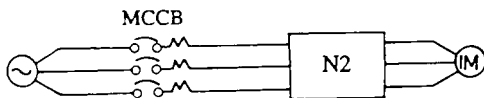

- A general noise filter may not provide rightful results

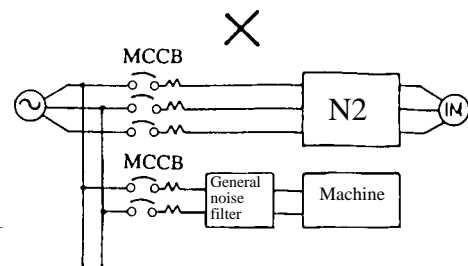

- Add a noise filter or separation transformer when the inverter shares the power line with other machines.

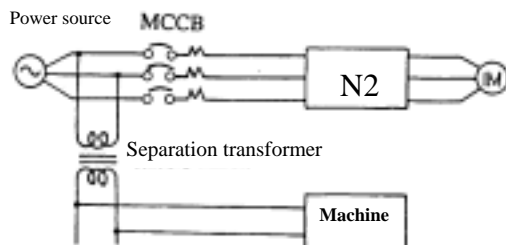
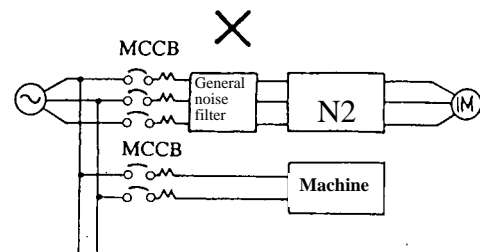
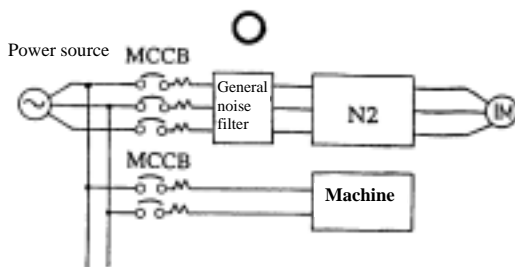

- A noise filter in the output of the main circuit can suppress conductive noise. To prevent radiative noise, the wires should be put in a metal pipe and distance from signal lines of other control machines for more than 30 cm.

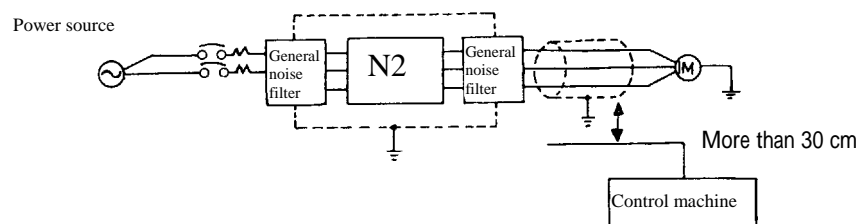

When the connection between the inverter and the motor is too long, consider the voltage drop of the circuit. Phase-to-phase voltage drop (V) =  $\sqrt{3} \times \text{resistance of wire (}\Omega/\text{km)} \times \text{length of line (m)} \times \text{current} \times 10^{-3}$ . And the number of carriers must be adjusted based on the length of the line.

The length of the line between the inverter and the motor	Less than 50m	Less than 100m	More than 100m
Number of carriers allowed	Below 12KHz	Below 10KHz	Below 5KHz
Settings of Fn_43 parameter	15	12	9

- (B) The wiring of the control circuit must be separated and routed away from the main circuit control line or other high voltage or current power lines to avoid noise interference.
- To avoid error actions caused by noise interference, shield the control circuit wiring with a twisted wire, and connect the shielding wire to a ground terminal. See the figure below.

The wiring distance should not exceed 50 m.

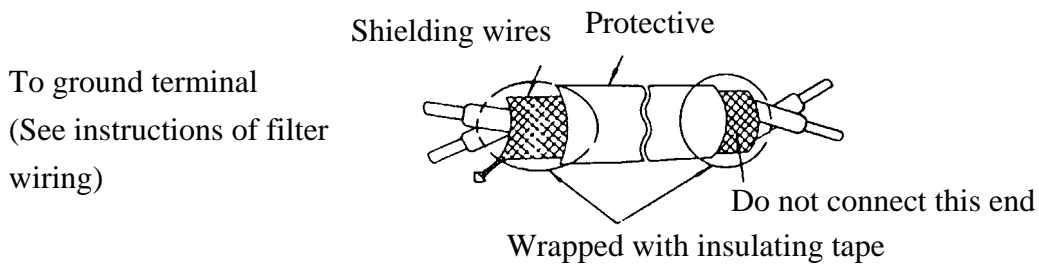

- (C) Ground the ground terminal of the inverter properly. **200V class: Ground to 100** or less, **400V class: Ground to 10** or less.

- Ground wiring is based on the electrical equipment technical basis (AWG) and should be made as short as possible.
- Do not share the ground of the inverter to other high current loads (welding machine, high power motor). Connect the terminal to its sole ground.
- Do not make a loop when several inverters share a common ground point.

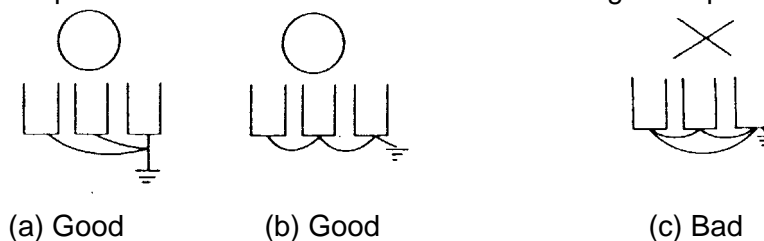

- (D) To ensure maximum safety, use proper wire gauges for the main power circuit and control circuit according to relative regulations.
- (E) After wiring, check that the wiring is correct, wires are intact, and terminal screws are secured.

# Wiring & Remote Control Functions:

## Internal Connections

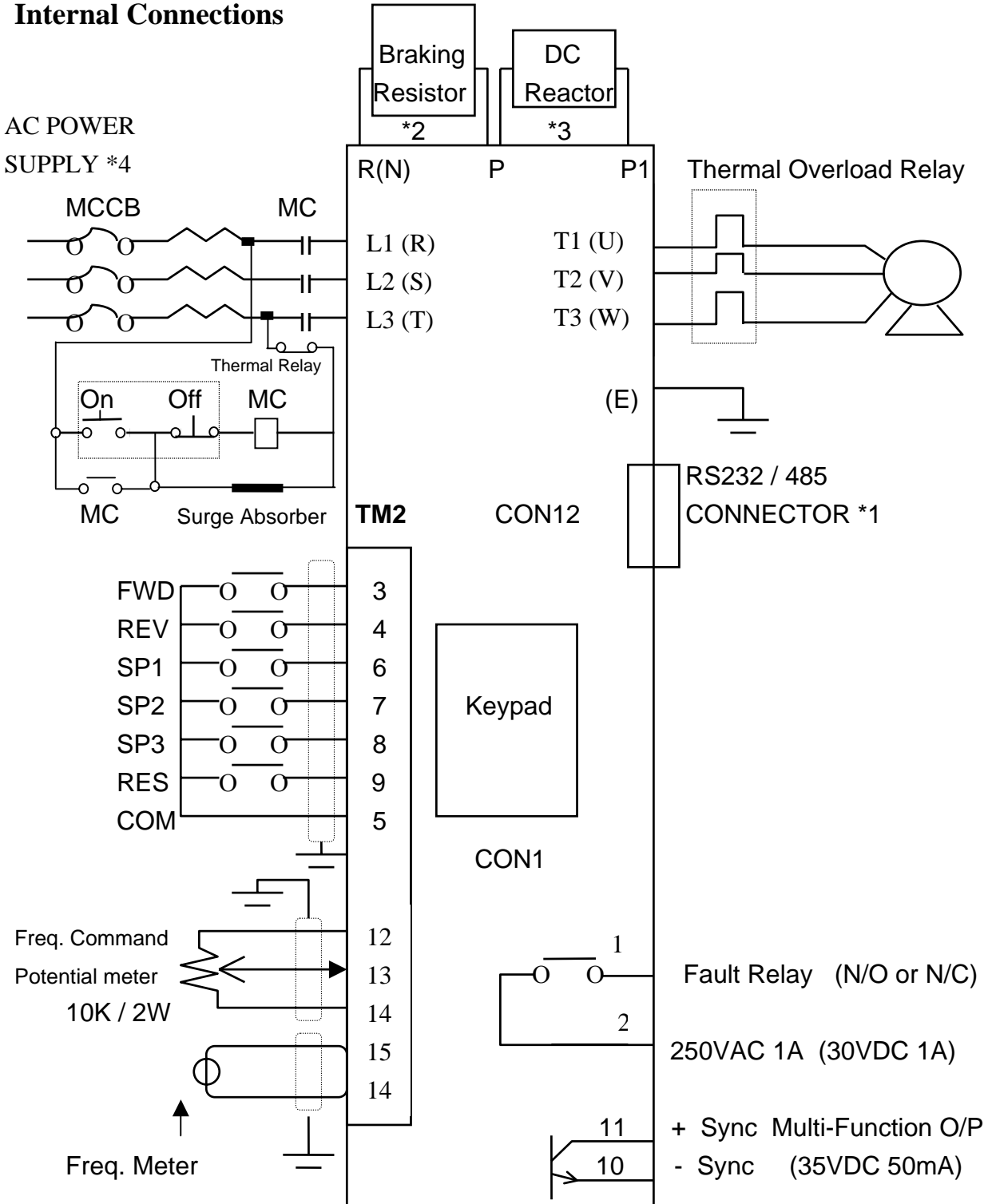

\*1: Please use Jumper to short Pin 1 and Pin 2 of CON12 for N2 Series M type when CON12 is not used. In N2 Series H type the Jumper is needless.

\*2: Please refer to the illustration of (P, R) or (P, N) in the manual.

\*3: 15Hp above only.

\*4: For single applications connect power to L1 & L2.

**General Wiring Instructions:**

**Note:**

The drive can be completely controlled by the Keypad, if you chose to use the TM2 control terminal strip, please see the following instructions.

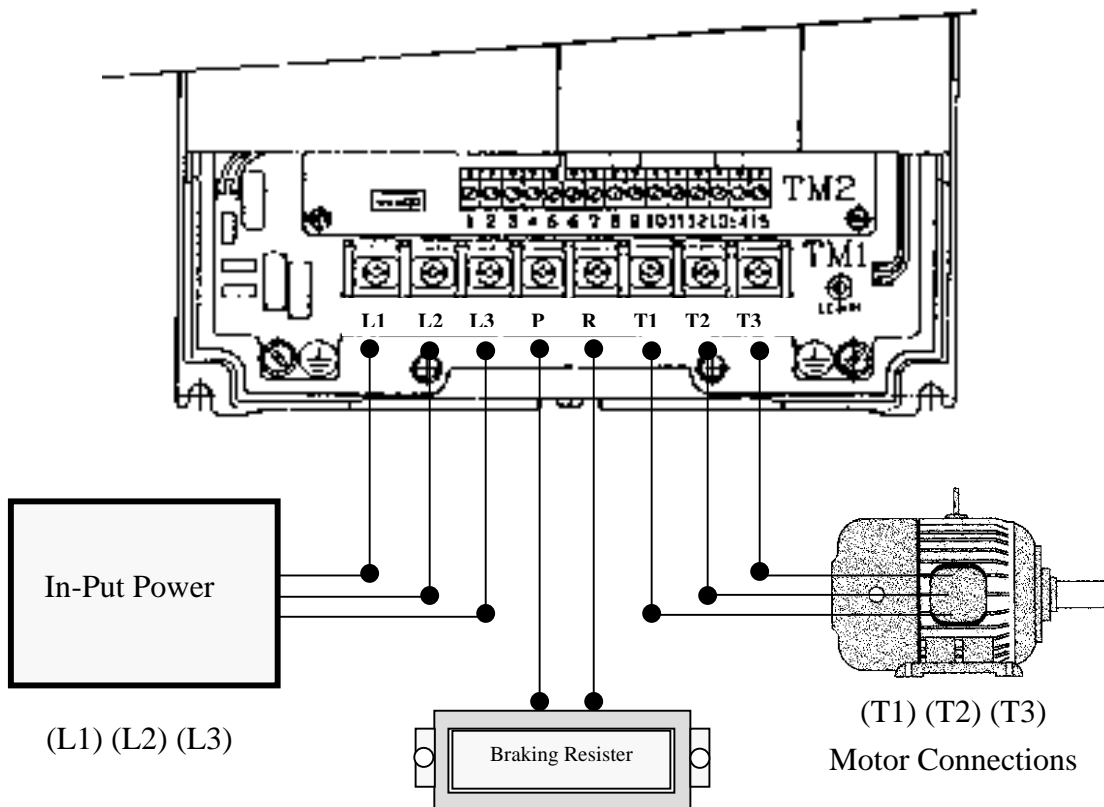
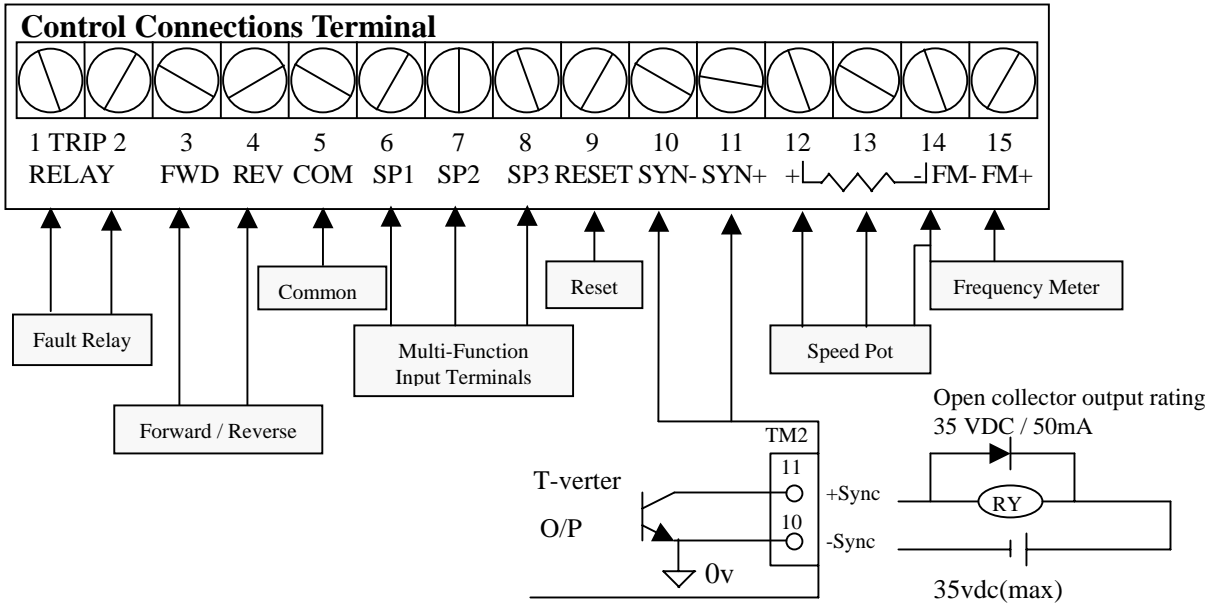

### Functional description for the main circuit power terminals (TM1)

SYMBOL	FUNCTION DESCRIPTION
L1 (R)	Input terminals of AC line power: Single phase: L1 / L2 Three phases: L1 / L2 / L3
L2 (S)	
L3 (T)	
P, R	External Braking Resistor Terminals, for 1/2~10Hp used only.
P1, P	External DC Reactor Terminals, for 15~30Hp used only.
P, N	External Braking unit terminals. (P for positive, N for negative)
T1 (U)	Output terminal to motor.
T2 (V)	
T3 (W)	

### Function description for the control terminals (TM2)

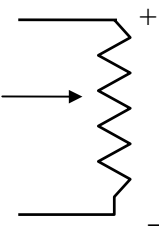

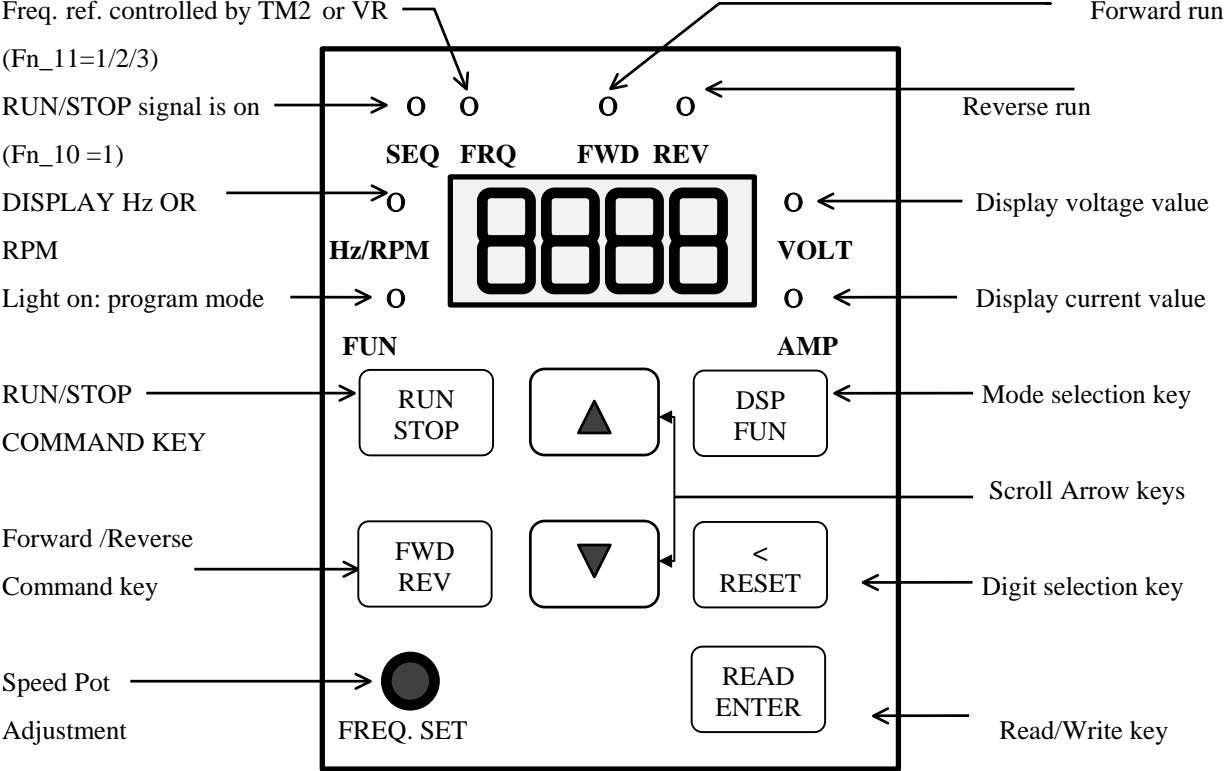

	SYMBOL	FUNCTION DESCRIPTION	
1	TRIP	Fault relay output terminals: (refer to <b>Fn_97, 98</b> )	
2	RELAY	Contact rating: 250VAC/1A (30V DC/1A)	
3	FWD	Operation control terminals	
4	REV	(Refer to <b>Fn_03</b> )	
5	COM	Ground common for terminal 3/4/6/7/8/9	
6	SP1	Multifunction input terminals (refer to <b>Fn_56~Fn_58</b> )	
7	SP2		
8	SP3		
9	RESET	Reset terminal (refer to <b>Fn_16</b> )	
10	SYN-	Negative terminal for multi-function output ( <b>Fn_61</b> )	
11	SYN+	Positive terminal for multi-function output ( <b>Fn_61</b> )	
12		+5V	Power terminal of potentiometer (Pin 3)
13		Analog Input	Analog freq. signal input terminal ( <b>Fn_26 ~ Fn_29</b> ) (pin 2 of potentiometer or positive terminal of 0-5v / 0-10V / 4-20mA)
14		Analog Common	Common terminal for analog freq. (pin 1 of potentiometer or negative Terminal of 0-5V/0-10V/4-20mA)
15	FM +	Analog Output (+)	Multi-function output terminal (Refer to <b>Fn_46</b> ) Range of output the signal: 0 -10V DC

# Keypad Operations:

## Keypad Illustration

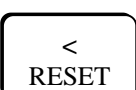

## Keypad Function:

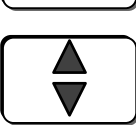
- 
  - Run / Stop Button Used for Start / Stop commands from the Keypad
- 
  - DSP / FUN Button Used for Displaying Functions and Meters
- 
  - FWD / REV Button Used for Foreword / Reverse commands from the Keypad
- 
  - < / Reset Button Used for moving Diagonally and Resetting the Drive
- 
  - READ / ENTER Used for Reading and Entering Functions
- 
  - ▲ ▼ Arrows are used for moving through and Changing Parameters

## Parameter List

Function	Fn_ xx	Description	Set Unit	Range	Factory Setting	Page
Drive Capacity	0	Drive Capacity Selection	1	1-40	*3	30
Accel. Time	1	Accel. Time 1	0.1 sec	0.1-3600 sec	10 sec*1	30
Decel. Time	2	Decel. Time 1	0.1 sec	0.1-3600 sec	10 sec*1	30
Stop / Start Control Terminal 2	3	xx00 : FWD/STOP, REV/STOP xx01 : FWD/REV, RUN/STOP xx10 : 3 wire Start / Stop Control x0xx : REV Command Enable x1xx : REV Command Disable 0xxx : Setting frequency will remain at last output frequency when T-verter stops and Fn_11 = 3 1xxx : Setting frequency will be 0 (zero) when T-verter stops and Fn_11 = 3			0000	31
Parameter Lock Out	4	xxx0 : Enable ( <b>Fn_17 - 25</b> ) xxx1 : Disable ( <b>Fn_17 - 25</b> ) xx0x : Enable (Functions except <b>Fn_17 - 25</b> ) xx1x : Disable (Functions except <b>Fn_17 - 25</b> )			0000	32
V/F Pattern	5	V/F pattern selected	1	0-18	9 / 0*4	32
Freq. Limit	6	Freq. output upper limit	0.01 Hz	0-400 Hz	60 / 50*4	34
Freq. Limit	7	Freq. output lower limit	0.01 Hz	0-400 Hz	0 Hz	34
Target Speed	8	Up-to desired frequency setting	0.01 Hz	0-400 Hz	0 Hz	34
Detection	9	Up-to frequency setting detection width (+/- Fn_9)	0.01 Hz	0-30 Hz	0 Hz	34
Start / Stop Selection	10	0 : Controlled by Keypad 1 : Controlled by <b>TM2</b>			0	35
Freq. Command Selection	11	0 : Controlled by (Fn_25) Master Reference at Keypad 1 : Controlled by VR on Keypad 2 : Controlled by VR on <b>TM2</b> (terminal 12-14) or analog signal. 3 : Controlled by TM2 using multi-function inputs 6-7-8(see Fn_56~Fn58)			0	35



Function	Fn_ xx	Description	Set Unit	Range	Factory Setting	Page
Stall Prevention	12	xxx0 : Stall prevention during accel. enable xxx1 : Stall prevention during accel. disable xx0x : Stall prevention during decel. enable xx1x : Stall prevention during decel. disable x0xx : Stall prevention during running enable x1xx : Stall prevention during running disable 0xxx : Stall prevention decel. time set by Fn_02 1xxx : Stall prevention decel. time set by Fn_15			0000	36
	13	Stall prevention starting level during accel	1%	30-200%	110%	36
	14	Stall prevention level during running	1%	30-200%	160%	36
	15	Decel time during stall prevention	0.1 sec	0.1-3600 sec	3 sec*1	36
Direct start & Reset & numbers of input signal scanning	16	xxx0 : Direct start enable when remote RUN command ON xxx1 : Direct start disable when remote RUN command ON xx0x : Reset effective only if remote RUN command OFF xx1x : Reset effective disregard of remote RUN command condition 00xx : TM2 will scan 10 times 01xx : Tm2 will scan 5 times 10xx : Tm2 will scan 3 times 11xx : TM2 will scan 1 times			0000	37
	17	Pre-Set Speed 1 *1	0.01 Hz	0-400 Hz	5.00 Hz	37
	18	Pre-Set Speed 2 *1	0.01 Hz	0-400 Hz	10.00 Hz	37
	19	Pre-Set Speed 3 *1	0.01 Hz	0-400 Hz	20.00 Hz	37
	20	Pre-Set Speed 4 *1	0.01 Hz	0-400 Hz	30.00 Hz	37
	21	Pre-Set Speed 5 *1	0.01 Hz	0-400 Hz	40.00 Hz	37
Pre-Set Speed	22	Pre-Set Speed 6 *1	0.01 Hz	0-400 Hz	50.00Hz	37
	23	Pre-Set Speed 7 *1	0.01 Hz	0-400 Hz	60.00 Hz	37
Jog Speed	24	Jog freq. Reference *1	0.01 Hz	0-400 Hz	2.00 Hz	38
Master freq.	25	Master freq. reference from the Keypad *1	0.01 Hz	0-400 Hz	5.00 Hz	38
Analog input Frequency Command	26	Freq. reference	0.01 Hz	0.0-400 Hz	0 Hz*1	39
	27	Voltage reference ratio 1	0.1 %	0-100.0%	0%*1	39
	28	Voltage reference ratio 2	0.1 %	0-999.9%	100%*1	39
Command	29	Positive / Negative direction	1	0 : Positive 1 : Negative	0*1	39
	30	Voltage of power supply	0.1 V	180 - 528 V	*3	40

Function	Fn_ xx	Description	Set Unit	Range	Factory Setting	Page
Momentary Power	31	Momentary power loss ride through time	0.1 sec	0-2 sec	0.5 sec	40
Loss Ride Through	32	xxx0 : Disable          xxx1 : Enable			0	40
Analog command Scan Time	33	Tm2 terminal 13 Analog input Scan time	1	1-100	100	40
Auto Restart	34	Auto Restart Time	0.1 sec	0-800 sec	0 sec	41
	35	No. of Auto Restart Attempts	1	0-10	0	41
Motor poles	36	No. Of Motor Poles	2 P	2-72 pole	4P	41
V/F Pattern	37	Max. freq.	0.01 Hz	50-400 Hz	60 / 50 Hz*4	42
	38	Max. voltage ratio	0.1%	0-100%	100%	42
	39	Mid. freq.	0.01 Hz	0.11-400 Hz	3.0/2.5 Hz*4	42
	40	Mid. voltage ratio	0.1%	0-100%	7.5 % (6.5%)	42
	41	Voltage ratio at 0.1 Hz	0.1%	0-100%	7.5% (6.5%)	42
Starting freq.	42	Start freq. adjustment	0.01 Hz	0.1-10 Hz	1 Hz	42
Carrier freq.	43	Carrier freq. adjustment	1	0-15	14(12)	42
Stopping mode	44	xxx0 : Decel. to stop xxx1 : Free run to stop			0000	43
Multi-function	45	Gain: Analog Output	1%	0-200 %	100%*1	43
Analog Output Selection (terminals) (14 & 15)	46	0 : Output freq. (Fn 6 max.) 1 : Set freq. (Fn 6 max.) 2 : Output voltage 3 : DC voltage			0*1	43
Display mode	47	xxx0 : Output voltage (Vac) display disable xxx1 : Output voltage (Vac) display enable xx0x : DC voltage display disable xx1x : DC voltage display enable x0xx : Output current (Iac) display disable x1xx : Output current (Iac) display enable			0000*1	43

Function	Fn_ xx	Description	Set Unit	Range	Factory Setting	Page
Dynamic braking & Priority of Stopping & Speed search & AVR control	48	xxx0 : Enhanced braking capacity xxx1 : Standard braking capacity xx0x : STOP key effective in remote control mode xx1x : STOP key ineffective in remote control mode x0xx : Speed search controlled by terminals on TM2 x1xx : Speed search effective when T-verter start 0xxx : AVR function effective 1xxx : AVR function ineffective			0000	44
Accel./Decel. Time 2	49	Accel. Time 2	0.1 sec	0.1-3600 sec	10.0 sec*1	44
	50	Decel. Time 2	0.1 sec	0.1-3600 sec	10.0 sec*1	44
Display mode	51	Display mode selection	1	0-5	0*1	45
	52	Line Speed Display	1	0-9999	1800*1	45
DC Braking	53	DC Braking Time	0.1 sec	0-25.5 sec	0.5 sec	45
	54	DC Braking injection freq.	0.1 Hz	0.1-10 Hz	1.5 Hz	45
	55	DC Braking level	0.1 %	0-20 %	8 % (6%)	45
Multi function input	56	Multi-input 1 (terminal 6)	00 : SP1      01 : SP2 02 : SP3      03 : Jog 04 : Accel / Decel time selection 05 : External emergency stop 06 : External coast stop		00	45
	57	Multi-input 2 (terminal 7)	07 : Speed search 08 : Energy saving 09 : control signal selection 10 : Communication selection 11 : Accel. / Decel. Prohibit 12 : Up command		01	45
	58	Multi-input 3 (terminal 8)	13 : Down command 14 : Sequence Control 15 : Master / Auxiliary speed 16-31 : Change 00-15 from Normal open to normal close		02	45
	59	Reserved for future use				
	60	Reserved for future use				

Function	Fn_ xx	Description	Set Unit	Range	Factory Setting	Page
Multi-function output	61	Multi-output 1 (terminal 10 & 11)		00: Run mode 01: At Target Speed 02: Set Frequency (Fn_08/09) 03 Frequency Detection > (Fn_08) 04 Frequency Detection < (Fn_08) 05 Over Current Detection 06 Change 00-05 (NO) to (NC)	00	68
	62	Reserved for future use				
	63	Reserved for future use				
	64	Reserved for future use				
Skip Frequency Control	65	Setting prohibited freq. 1	0.01 Hz	0-400 Hz	0 Hz	49
	66	Setting prohibited freq. 2	0.01 Hz	0-400 Hz	0 Hz	49
	67	Setting prohibited freq. 3	0.01 Hz	0-400 Hz	0 Hz	49
Band Width	68	Setting prohibited freq. range	0.01 Hz	0-10 Hz	0 Hz	49
Electronic Thermal Over-load Protection	69	xxx0 : Electronic thermal motor protection enable xxx1 : Electronic thermal motor protection disable xx0x : Electronic thermal characteristics in accordance with standard motor xx1x : Electronic thermal characteristics in accordance with a special motor x0xx : <u>Constant Torque</u> : T-verter protection OL : 103 % continues 150 % for one minute x1xx : <u>Variable Torque</u> : T-verter protection OL : 113 % continues 123 % for one minute 0xxx : Free run to stop after electronic thermal motor protection is energized 1xxx : Operation continued after electronic thermal Motor protection is energized			0000	49
Reference Amps	70	Motor rated current	0.1 A		Specs	49
Torque boost	71	xxx0 : Free run to stop after electronic thermal T-verter protection is energized. xxx1 : Operation continued after electronic thermal T-verter protection is energized. x0xx : Torque boost enable x1xx : Torque boost disable			0000	52

Function	Fn_ xx	Description	Set Unit	Range	Factory Setting	Page
Torque boost	72	Torque Boost gain	0.1 %	0.0-10.0 %	0.0 %*1	52
	73 74	Reserved for future use				
Slip compensation	75	Motor current without load	0.1A		Specs	52
	76	Motor rated slip	0.01 Hz	0.00- 6.00 Hz	0.00 Hz*1	52
Over-torque Control	77	xxx0 : Over-torque detection disable xxx1 : Over-torque detection enable xx0x : Enable only if at set freq. xx1x : Enable during operation x0xx : Operation continued after over-torque is detected x1xx : Free run to stop after over-torque is detected			0000	52
Detection Level	78	Over-torque detection level	1 %	30-200 %	160 %	53
Detection Time	79	Over-torque detection time	0.1 sec	0-25 sec	0.1 sec	53
S Curve	80	S curve time 1 in the period of Accel./Decel. Time 1	0.1 sec	0-4 sec	0.2 sec	53
	81	S curve time 2 in the period of Accel./Decel. Time 2	0.1 sec	0-4 sec	0.2 sec	53
Energy Saving	82	xx00: Energy saving disable xx01: Energy saving controlled by multi-input terminals using the Preset Speed Functions xx0x: Set freq. output after process timer finishes counting			0000	54
	83	Energy saving gain	1 %	0-100 %	80 %*1	54
Sequence Control	84	xxx0 : Process timer disable xxx1 : Process timer enable xx0x : Set freq. output after process timer finishes counting xx1x : Zero speed output after process timer finishes counting x1xx : Process Sequence Auto repeat			0000	55
Timer	85	Process timer 1	0.1 sec	0-3600 sec	0 sec	55
Timer	86	Process timer 2	0.1 sec	0-3600 sec	0 sec	55
Timer	87	Process timer 3	0.1 sec	0-3600 sec	0 sec	55
Timer	88	Process timer 4	0.1 sec	0-3600 sec	0 sec	55
Timer	89	Process timer 5	0.1 sec	0-3600 sec	0 sec	55
Timer	90	Process timer 6	0.1 sec	0-3600 sec	0 sec	55
Timer	91	Process timer 7	0.1 sec	0-3600 sec	0 sec	55

Function	Fn_ xx	Description	Set Unit	Range	Factory Setting	Page
Vibration Control	92	Vibration control times	1	1-100	5[30]*1	56
	93	Vibration control gain	0.1 %	0-100 %	0 % [10%]*1	56
	94	Vibration control bias	1 %	0-30 %	0 %*1	56
Factory adjustment	95	Parameters for factory adjustment,				56
	96	Do Not Change.				
Fault Contact Control	97	xxx0 : Fault contact is not energized during auto restart operation xxx1 : Fault contact is energized during auto restart operation xx0x : Fault contact is not energized during momentary power loss Detection xx1x : Fault contact is energized during momentary power loss Detection x0xx : Fault contact is not energized during external Emergency Stop x1xx : Fault contact is energized during external Emergency Stop 0xxx : Fault contact is not energized during external base block 1xxx : Fault contact is energized during external base block			0000	57
	98	xxx0 : Fault contact is not energized after over-torque is detected xxx1 : Fault contact is energized after over-torque is detected xx0x : Fault contact is not energized after electronic thermal motor protection is acting xx1x : Fault contact is energized after electronic thermal motor protection is acting x0xx : Fault contact is normal open (N/O) x1xx : Fault contact is normal close (N/C) 0xxx : Fault contact is not energized after electronic thermal T-verter protection is acting 1xxx : Fault contact is energized after electronic thermal T-verter protection is acting			0000	57
	99	Reserved for future use				
Parameter Control for Communication	100	Communication identified no.	1	1-32	1 *2 *3	57
	101	Baud rate of communication	1	0: 4800 bps 1: 9600 bps 2: 19200 bps 3: 38400 bps	1 *2 *3	57

Function	Fn_ xx	Description	Set Unit	Range	Factory Setting	Page
Parameter Control for Communication	102	xxx0 : 1 stop bit xx0x : Even parity x0xx : With parity 0xxx : 8 bits data	xxx1 : 2 stop bits xx1x : Odd parity x1xx : Without parity 1xxx : 7 bits data		1100 *2 *3	57
	103~ 122	For factory setting only			*3	
Return to Factory Setting	123	1111: Reset to factory setting (for 60 Hz power system) 1110: Reset to factory setting (for 50Hz power system).			0000 *4	59
CPU version	124	CPU Software Version			*3	59
Fault Log	125	Fault Log for last three faults			1. --- 2. --- 3. ---	59

Note: \*1: Setting can be changed during run mode.

\*2: Setting cannot be changed in communication mode.

\*3: Setting will not change with “Reset to factory setting” function.

\*4: Refer to function description of Fn\_123.

( ): The factory setting of 15~30Hp only.

#### **SETTING THE RANGE:**

The setting of the Accel. & Decel. Times along with the frequency are only 4 digits when set by the keypad (for example: 3599 sec / 399.9 Hz),

But 5 digits (for example: 3599.9 sec or 399.99 Hz) are available when controlled by a programmable controller (PLC) or computer communication mode.

## Function Description

Fn\_00: Drive Capacity Selection = 1 - 40

Fn_00	MODEL NO
01	N2-2P5
02	N2-201
03	N2-202
04	N2-203
05	N2-205
06	N2-208
07	N2-210
08	N2-215
09	N2-220
40	N2-230

Fn_00	MODEL NO
10	N2-401
11	N2-402
12	N2-403
13	N2-405
14	N2-408
15	N2-410
16	N2-415
17	N2-420
18	N2-430

Fn\_01: Acceleration Time = 0.1 ~ 3600 Sec.

Acceleration time means the time it takes the drive to go from 0 speed to target speed. Using the keypad on the drive can set the acceleration time.

Press the  (Key), use your up and down arrow keys to find (Fn\_01)

Press the  (Key), use your up and down arrows to change the acceleration time.

Press the  (Key), again to store the setting.

Fn\_02: Deceleration Time = 0.1 ~ 3600 Sec.

Deceleration time means the time it takes the drive to go from one target speed to a slower target speed. The programming of the Deceleration function is the same as the Acceleration function above.



**Fn\_03 Start / Stop Control From Terminal 2**

Fn-03: Start / Stop Control for Remote Operation

**xx00**: FWD/STOP, REV/STOP

**xx01**: FWD/REV, RUN/STOP

**xx10**: 3 wire control

**x0xx**: REV command enable

**x1xx**: REV command disable

**0xxx**: During Fn\_11=3 ( TM-2 up & down control),

The setting frequency will remain at the last operational frequency when stopped.

**x1xx**: During Fn\_11=3 ( TM2 up/down control)

- Note:
- 1: Fn\_03 will be enabled only when Fn\_10 = 1(Remote control)
  - 2: The STOP” key on the Keypad can be use for emergency stopping at any time (Refer to Fn\_48 for additional stopping functions)

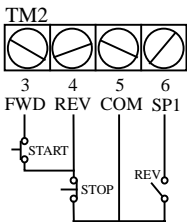

**Momentary Start / Stop Switch:**  
**Maintained Forward & Reverse Switch:**  
 Set: (Fn\_10 to 1)  
 Set: (Fn\_03 to 3 wire control) (XX10)

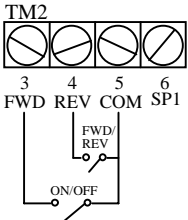

**Maintained Forward / Stop Switch:**  
**Maintained Reverse / Stop Switch:**  
 Set: (Fn\_10 to 1)  
 Set: (Fn\_03 to 0000)

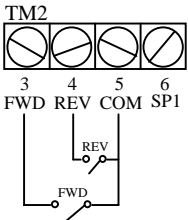

**Maintained Start / Stop Switch:**  
**Maintained Forward / Reverse Switch:**  
 Set: (Fn\_10 to 1)  
 Set: (Fn\_03 to XX01)

**Fn\_04 Parameter Lockout:**

<u>Parameter Lock Select</u>	xxx0 : Disable (Fn_17-25)
	xx01 : Enable (Fn_17-25)
	xx0x : Disable (Functions except Fn_17-25)
	xx1x : Enable (Functions except Fn_17-25)

**Fn\_05 V/F Pattern Setting / Custom or Preprogrammed:**

V/F Pattern selection = 0 –18 See next page

Fn\_30 : Voltage of power supply =200 - 480V

Fn_37 : Maximum frequency	= 50 - 400 Hz
Fn_38 : Maximum voltage ratio	= 0 - 100%
Fn_39 : Middle frequency	= 0.11 - 400 Hz
Fn_40 : Middle voltage ratio	= 0 - 100%
Fn_41 : Voltage ratio at 0.1 Hz	= 0 - 100%
Fn_48 : AVR control	= 0xxx, AVR function effective = 1xxx, AVR function ineffective

In order to build Custom V/F Patterns, (Fn\_05) must be set at 18.  
Please refer to (Fn\_37) and (Fn\_41).

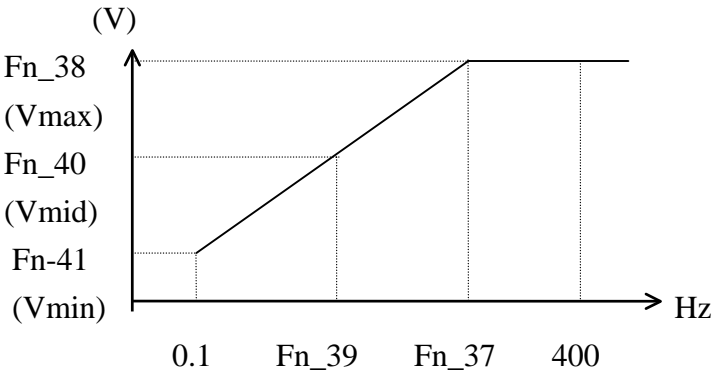

**Note:** That Automatic Voltage Regulator (AVR) will determine the actual output voltage when (Fn\_05) is set to 18.

Fn\_05 = 0 - 17 V/F Curves

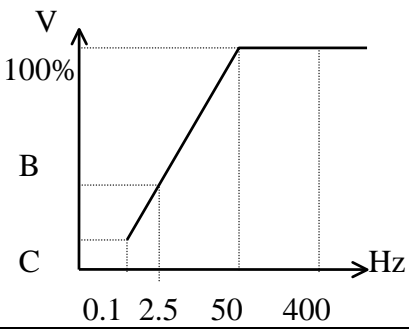
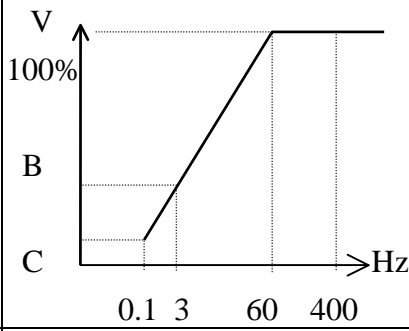
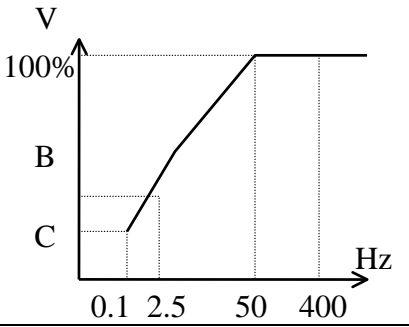
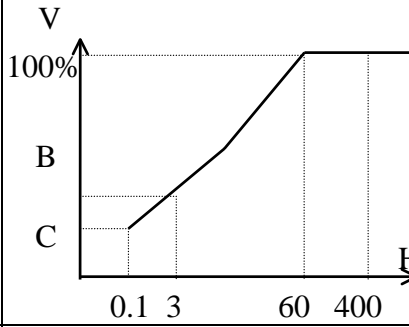
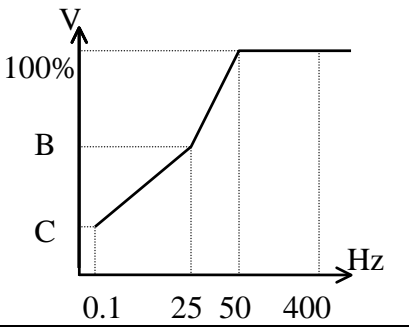
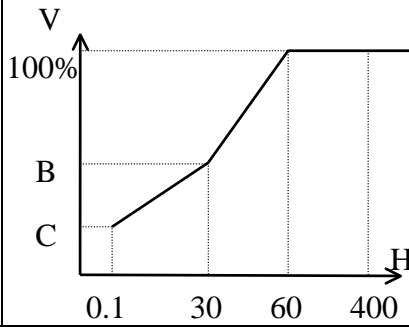
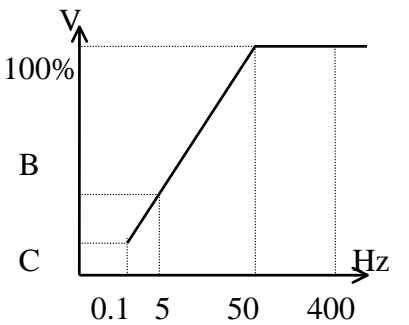
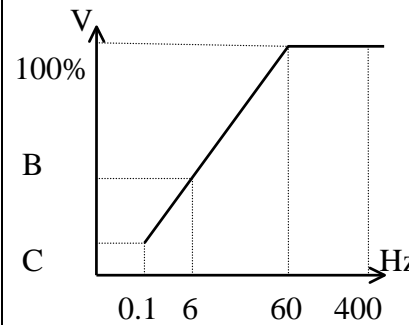
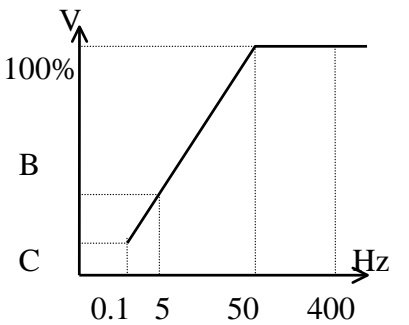
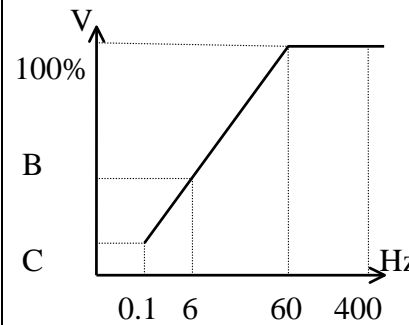
	Fn_05	50Hz	Fn_05	60Hz	
General Purpose	0		9		
	1 2 3		10 11 12		
High Starting Torque	4 5		13 14		
	Variable Torque Operation	6 7 8		15 16 17	
Constant HP Operation		6 7 8		15 16 17	

	Fn_05	B	C	Fn_05	B	C	Fn_05	B	C
2P5~203 401~405	0/9	7.5%	7.5%	3/12	20.0%	7.5%	6/15	15.0%	7.5%
	1/10	10.0%	7.5%	4/13	17.5%	7.5%	7/16	20.0%	7.5%
	2/11	15.0%	7.5%	5/14	25.0%	7.5%	8/17	25.0%	7.5%

205~210 408~410	0/9	7.5%	7.5%	3/12	12.0%	7.5%	6/15	10.4%	7.5%
	1/10	9.0%	7.5%	4/13	17.5%	7.5%	7/16	13.0%	7.5%
	2/11	10.5%	7.5%	5/14	25.0%	7.5%	8/17	15.4%	7.5%

	Fn_05	B	C	Fn_05	B	C	Fn_05	B	C
215~230	0/9	6.5%	6.5%	3/12	9.5%	4.9%	6/15	10.0%	5.1%
415~430	1/10	7.5%	6.1%	4/13	20.0%	6.1%	7/16	12.0%	4.7%
	2/11	8.5%	5.5%	5/14	25.0%	5.8%	8/17	14.0%	4.2%

**Fn\_06 Upper Frequency Limit**

You can adjust the maximum speed of the motor by raising the Upper Frequency limit at (Fn\_06)

**Fn\_07 Lower Frequency Limit**

You can set the minimum speed for the motor by adjusting the Lower frequency Limit at (Fn\_07)

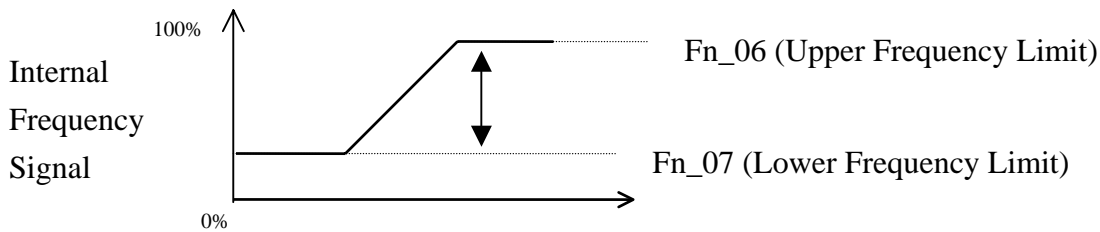

**Fn\_08 At Target Speed 0 ~ 400 Hz**

You can close a Multi-function output at terminal at a determined target speed at terminals (10 & 11), You must assign (Fn\_61) to ( 2~4 ) along with determining your target speed at Fn\_08

**Fn\_09 Target Speed Detection 0 ~ 30 Hz**

When the Fn\_61 set to 2, the terminals 10 & 11 status will follow the output frequency

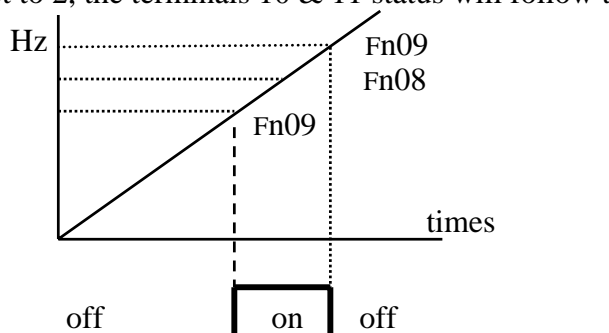

Note:

Terminals 10 & 11 are normally open during power off, and normally closed during power on.

### Fn\_10: Start / Stop Control

This parameter is used to decide if the Start and Stop function will be controlled by the Keypad or remote control TM2 (terminal 3 / 4).

0: Keypad control

1: Remote control TM2 (terminal 3 / 4 )

#### Note:

- When Fn\_10=1, please refer to the descriptions of Fn\_31/32/34/35, in order to avoid the damage to the human and the machine.
- The STOP key on the Keypad can still be used for emergency stopping even if the start / stop control is from terminal 2 (Fn\_10 =1). (Refer to Fn\_48)

### Fn\_11: Frequency Command Selection

0: Run by Fn\_25 Master Reference

1: Run by Speed Pot on Keypad

2: Run by Speed Pot on TM2 (terminal 12 / 13 / 14)

3: Run by multi-function input freq. command (terminal 6 / 7 / 8)

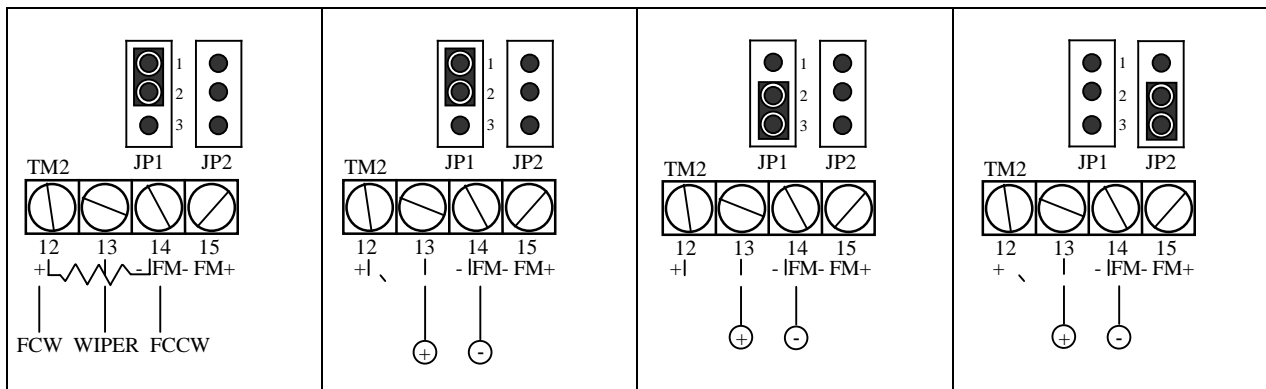

0 – 10 Vdc Speed Ref.

0 – 5 Vdc External

4 – 20mA Signal

0 – 10 Vdc External

(Fn_11) to 2 Use a (10K) (2 Watt) Pot with the wiper in Term (13) Jumper (JP1) pins 1&2	(Fn_11) to 2 For a Remote 5 Vdc Signal Jumper (JP1) Pins 1&2	(Fn_11) to 2 For a Remote Signal 4 ~ 20mA Jumper (JP1) Pins 2&3	(Fn_11) to 2 For an External Signal 0 – 10 Vdc Jumper (JP2) Pins 2&3
--	--	---	--

**Fn\_12: Stall Prevention**

- xxx0:** Stall prevention during Acceleration Enable
- xxx1:** Stall prevention during Acceleration Disable
- xx0x:** Stall prevention during Deceleration Enable
- xx1x:** Stall prevention during Deceleration Disable
- x0xx:** Stall prevention during Running Enable
- x1xx:** Stall prevention during Running Disable
- 0xxx:** Stall prevention Decel. Time set in (Fn\_02)
- 1xxx:** Stall prevention Decel. Time set in (Fn\_15)

**Fn\_13: Stall prevention level during Accel: 30% ~ 200%**

**Fn\_14: Stall prevention level during running: 30% ~ 200%**

**Fn\_15: Decel time during stall prevention: 0.1sec ~ 3,600 sec**

**Note:**

1. If the acceleration ramp time is set to fast for the size of the load, an over-current trip may occur during the acceleration period. Setting the proper stall prevention during acceleration can automatically extend the ramp time to prevent trip when acceleration time is too short.
2. If deceleration time is too short, an over-voltage may occur on DC BUS. Setting the proper stall prevention during deceleration T-verter can prevent an "OV" trip when deceleration time is too short.
3. In order to prevent abnormal overload trips during heavy running periods, the T-verter can lower the output frequency in accordance with deceleration time set by (Fn\_02) or (Fn\_15) when (Fn\_12) is (1xxx) or when operational current is over the value set in (Fn\_14) The T-verter will return to its normal operating frequency automatically after the current is back to normal conditions.

Fn_16: Direct Start / Scanning / Reset Options
--

- |       |
|-------|
| xxx0: |
|-------|

 Direct start enable when remote RUN command is ON
- |       |
|-------|
| xxx1: |
|-------|

 Direct start disable when remote RUN command is ON
- |       |
|-------|
| xx0x: |
|-------|

 Reset effective only if remote RUN command is OFF
- |       |
|-------|
| xx1x: |
|-------|

 Reset effective regardless of the remote RUN command condition
- |       |
|-------|
| 00xx: |
|-------|

 TM2 terminal will scan 10 times
- |       |
|-------|
| 01xx: |
|-------|

 TM2 terminal will scan 5 times
- |       |
|-------|
| 10xx: |
|-------|

 TM2 terminal will scan 3 times
- |       |
|-------|
| 11xx: |
|-------|

 TM2 terminal will scan once

Note:
-------

1. When (Fn\_16) is set at (xxx1) and the control mode is set for terminal 2 control (Fn\_10), the T-verter cannot start if the RUN switch is on when the power is engaged. The “STP1” LED will flash. On the Keypad the RUN switch must be turned OFF and ON again, in order for the T-verter to start.
  
2. Scanning the input signals at TM2 on terminals (3) (4) (5) (6) (7) (8) (9) (FWD) (REV) (SP1) (SP2) (SP3) (RESET) are set at (Fn\_16). If TM2 detects the same input signals for the programmed number of times in a row, the T-verter will treat the signal as a normal signal and execute it.

On the other hand, if TM2 detects the same input signals that are less than the number of times programmed, TM2 will interpret the signal as noise. Remark: The scan time is 2 ms

Fn_17~Fn_23 : Pre-Set Speeds and Timer Controls
---

Fn_17:	Pre-Set Speed 1:	0.01 Hz ~ 0-400 Hz
Fn_18:	Pre-Set Speed 2:	0.01 Hz ~ 0-400 Hz
Fn_19:	Pre-Set Speed 3:	0.01 Hz ~ 0-400 Hz
Fn_20:	Pre-Set Speed 4:	0.01 Hz ~ 0-400 Hz
Fn_21:	Pre-Set Speed 5:	0.01 Hz ~ 0-400 Hz
Fn_22:	Pre-Set Speed 6:	0.01 Hz ~ 0-400 Hz
Fn_23:	Pre-Set Speed 7:	0.01 Hz ~ 0-400 Hz

Fn\_24: Jog Speed Reference = 0 - 400 Hz

Fn\_25: Master Speed Reference from Keypad = 0 - 400 Hz.

**Note:**

1. The T-verter will be operating under the Jog Speed function at (Fn\_24) you can assign either (Fn\_56) (Fn\_57) or (Fn\_58) to handle the jog function.
2. The T-verter will operate under the Pre-set speed frequencies when (Fn\_56) (Fn\_57) or (Fn\_58) are assigned to this function.
3. If the process timer in (Fn\_84) is turned on and (Fn\_56) (Fn\_57) or (Fn\_58) have been assigned for input functions, if a pulse signal or contact closure is received on the multi-function input, the T-verter will run at the pre-set time based on the setting in (Fn\_85) (Fn\_86) (Fn\_87) (Fn\_88) (Fn\_89) (Fn\_90) and (Fn\_91), The sequence will continue until all process timers are finished, the T-verter will then returns to the frequency set by keypad or an external Speed Pot or jump back to 0 speed to receive the next sequence.
4. A New speed setting or timer sequence cannot be inserted during an active sequence.

Pre-set Speed Terminal 6	Pre-set Speed Terminal 7	Pre-set Speed Terminal 8	Jog Terminal	Output frequency (Hz)	Operation time
X	X	X	X	Fn_25	
O	X	X	X	Fn_17	Fn_85
X	O	X	X	Fn_18	Fn_86
O	O	X	X	Fn_19	Fn_87
X	X	O	X	Fn_20	Fn_88
O	X	O	X	Fn_21	Fn_89
X	O	O	X	Fn_22	Fn_90
O	O	O	X	Fn_23	Fn_91
--	--	--	O	Fn_24	

O: TERMINAL ON

X: TERMINAL OFF

--: NO EFFECT



Fn_26: Frequency Reference:	0.0	~	400 Hz
Fn_27: Voltage Reference Ratio 1:	0.0	~	100%
Fn_28: Voltage Reference Ratio 2:	0.0	~	999.9%
Fn_29: Positive or Negative Direction	0: Positive	1: Negative	

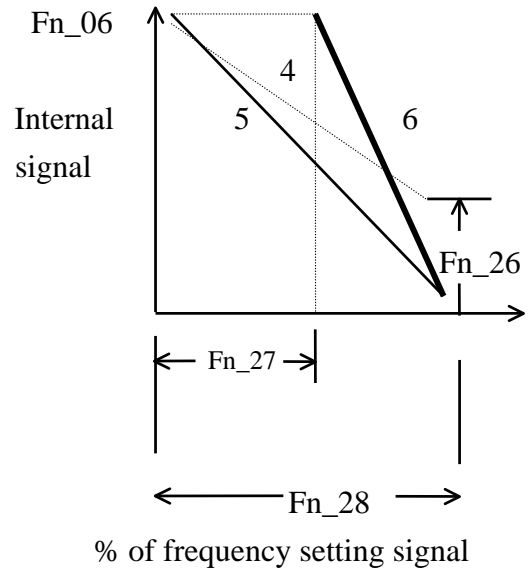
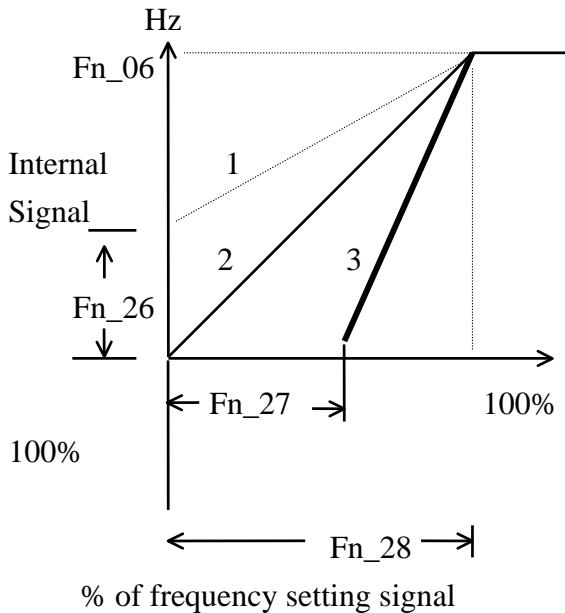

Curves	Fn_26	Fn_27	Fn_28	Fn_29
Curve 1	Set freq.	Set 0	Set %	0
Curve 2	Set 0	Set 0	Set %	0
Curve 3	Set 0	Set %	Set %	0
Curve 4	Set freq.	Set 0	Set %	1
Curve 5	Set 0	Set 0	Set %	1
Curve 6	Set 0	Set %	Set %	1

**Note:**

- (Fn\_26) (Fn\_27) (Fn\_28) and (Fn\_29) will only work with (Fn\_11) set at 1 or 2 (Speed Controlled by Keypad or TM 2)
- (Fn\_27) can be set as follows for (curve 3)
  - If the signal is 1~ 5 V, (Fn\_27) will equal the voltage of 0 Hz divided by 5V, i.e.  $1/5 * 100\% = 20\%$
  - If the signal is 4 ~ 20 mA, (Fn\_27) will equal the current of 0 Hz divided by 20 mA. i.e.  $4/20 * 100\% = 20\%$
  - If the signal is 0~ 10V, use the same method as above, i.e.  $0/10 * 100\% = 0\%$
- Setting up (Fn\_28) If the signal is a 0~ 20 mA, (Fn\_28) will equal to the current of (Fn\_06) divided by 20 mA. The (Fn\_28) must be greater than (Fn\_27)

**Remarks:** Signals from a VR on TM2 or the Keypad are a 0~5V signal. The Analog input terminal of the terminal block can accept a (0~5 V) (0~10V) (0~20 mA) signal.

### Fn\_30: Input Voltage Selection

Fn\_31: Momentary power loss ride through time: 0 - 2 sec

Fn\_32: Auto-restart after momentary power Loss  Auto-restart disabled  
 Auto-restart enabled

1. Inverter will stop when the voltage is lower than the low voltage protection level. The Inverter can restart automatically by using the speed search function.
2. During a Momentary Power Loss, the response time may vary slightly between each model, the response range will be restored accordingly from 0.7 sec to 2 sec.
3. When Fn\_32=XXX0:
  - (1)Power up after momentary power loss, the inverter will not start. Even under Fn\_35>0.
  - (2)If the momentary power loss is long, the inverter must be restart manually. The operation of the inverter is based on the setup of Fn\_10/16 and the condition of external switch.
4. When Fn\_32=XXX1:
  - (1)If the momentary power loss is less than Fn\_31, the inverter resumes operation automatically via speed search at 0.5 seconds after power up. The number of auto-restart times is not limited by Fn\_34.
  - (2)If the momentary power loss is long, the operation of the inverter is based on the setup of Fn\_10/16 and the condition of external switch.
  - (3)If the time of momentary loss is between the above two, whether the inverter will auto-restart depends on Fn\_35:
    - 1.Fn\_35=0: auto-restart disabled.
    - 2.Fn\_35=1~10: auto-restart enabled 1~10 times.
5. When restart the inverter, the operation of the inverter is based on the setup of Fn\_10/16 and the condition of external switches (FWD/REV button).
  - (1)When Fn\_10=0, the inverter will not start after restart.
  - (2)When Fn\_10=1 and the external switch (FWD/REV button) is OFF, the inverter will not start after restart.
  - (3)When Fn\_10=1 and the external switch (FWD/REV button) is ON, and Fn16=XXX0, the inverter will start automatically after restart. Attention: Base on safety reason, please turn off the external switch (FWD/REV button) after power loss to avoid possible damage to the machine and the human body after sudden regeneration of power.

### Fn\_33: Analog command Scan Times

1 - 100

Scanning the input signals at **TM2** on Terminals (13). The unit of scan time is 2ms.

Fn\_34: Auto Restart Interval: 0.1 ~ 800 sec

Fn\_35: Number of Auto Restart Attempts (0 -10) times

1. When Fn\_35=0, the inverter will not auto-restart after a malfunction break away from operation. (Except for momentary power loss, please refer to Fn\_31/32 for details)
2. When Fn\_35>0, Fn34=0: The inverter will use speed search to pull the frequency back to the frequency before the trip from free status in 0.5 second and then accelerate or decelerate to preset frequency. (Except for momentary power loss, please refer to Fn\_31/32 for details).
3. When Fn\_35>0, Fn34>0: The inverter will free run for a certain period (ser by Fn\_34) and then accelerate or decelerate from Fn\_42 to preset frequency. (Except for momentary power loss, please refer to Fn\_31/32 for details)
4. The number of Auto Restarts will be reset under the following conditions:
  - (1). Fault is not detected for 10 minutes (either in Run or Stop Mode).
  - (2). Press "RESET" Key or reset terminal of **TM2**.

Display Meter Control

(Meters)

Fn\_36: Numbers of motor poles = 2 - 72 poles

(Meters)

Fn_47 =	<input type="checkbox"/> xxx0 :	Output Voltage display	disable
	<input type="checkbox"/> xxx1 :	Output Voltage Display	enable
	<input type="checkbox"/> xx0x :	DC Voltage Display	disable
	<input type="checkbox"/> xx1x :	DC Voltage Display	enable
	<input type="checkbox"/> x0xx :	Output Current	disable
	<input type="checkbox"/> x1xx :	Output Current	enable

(Meters)

Fn\_51: Displays frequency in (Hz); (Pre-set frequency) (Operation frequency)

0. Displays Frequency in (Hz)
1. Displays RPM of motor; numbers of poles set by Fn\_36.
2. Line speed display mode: in integral (xxxx)
3. Line speed display mode: in one digit decimal (xxx.x)
4. Line speed display mode: in two digits decimal (xx.xx)
5. Line speed display mode: in three digits decimal (x.xxx)

(Meters)

Fn_37:	Maximum Frequency	0.01 Hz	=	50 to 400 Hz
Fn_38:	Maximum Voltage Ratio	0.1 %	=	0 to 100 %
Fn_39:	Middle Frequency	0.01 Hz	=	0.11 to 400 Hz
Fn_40:	Middle Voltage	0.1 %	=	0 to 100 %
Fn_41:	Minimum Voltage Ratio	0.1 %	=	0 to 100 %

In order to build Custom V/Hz Patterns, (Fn\_05) must be set at 18.

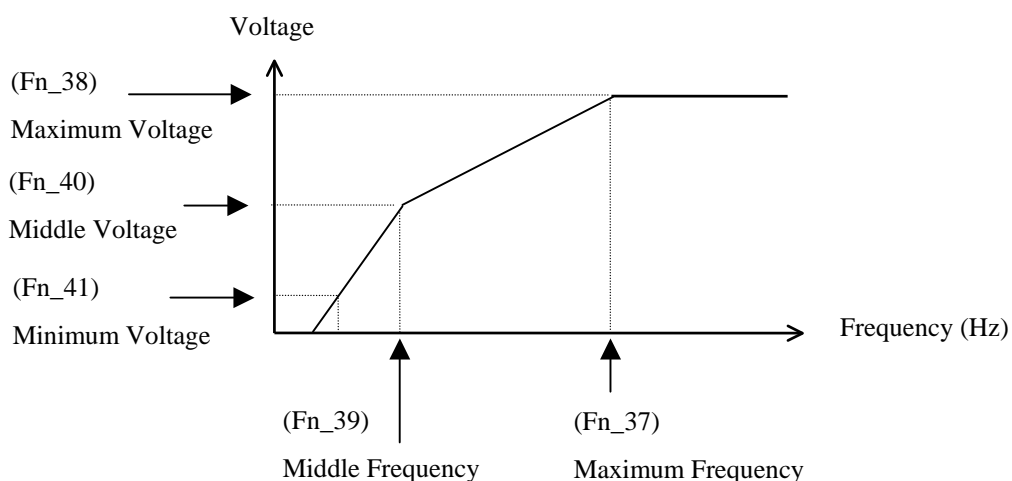

Fn_42: Starting Frequency	= 0.1 - 10 Hz
---------------------------	---------------

The T-verter can start at 5 Hz and still have an operational control range of 0.1 ~ 60 Hz. To accomplish this (Fn\_07) will need to be set at 0 Hz, and (Fn\_42) at 5 Hz.

Fn_43: Carrier frequency	= 1 -12 kHz
--------------------------	-------------

Fn_43	Carrier freq.	Fn_43	Carrier freq.	Fn_43	Carrier freq.	Fn_43	Carrier freq.
0	1 kHz	4	2.4 kHz	8	4.8 kHz	12	8 kHz
1	1.2 kHz	5	3 kHz	9	5 kHz	13	9 kHz
2	1.8 kHz	6	3.6 kHz	10	6 kHz	14	10 kHz
3	2 kHz	7	4 kHz	11	7.2 kHz	15	12 kHz

**Note:**

An IGBT type T-verter can provide a lower audible motor noise using a higher carrier frequency. However, a drive with too high of a carrier frequency may lead to interference in other electronic equipment. It's recommended that a carrier frequency of not more than 10 or 12 kHz be used for protection of the motor and surrounding equipment that may be sensitive to high carriers.

## Fn\_44: Stopping Mode and Braking Resistor Protection

- xxx0 : Decel. to stop
- xxx1 : Free run to stop
- xx0x : Braking resistor overheat protection disable
- xx1x : Braking resistor overheat protection enable

### Note:

If the (Fn\_44) is set at free run to stop, the T-verter will cut off the output after receiving a stop instruction and the motor will coast to a stop.

If the (Fn\_44) is set for deceleration to stop, the T-verter will decelerate to the frequency set by (Fn\_54) after receiving deceleration instructions, the output voltage level set at (Fn\_55) the T-verter will stop after the time period set by (Fn\_53)

If the (Fn\_44) is set for protection of the Built-in braking transistor, and operation of drive is too frequently decelerate, the braking transistor and braking resistor may overheat and T-verter will trip. OH1 will show this on Keypad display. The T-verter can be manually restarted after the braking resistor has cooled off. If the braking resistor is damaged and leads to OV-C trip, deceleration time must be increased or the external braking resistor replaced.

## Fn\_45: Adjustment for Analog out put for Meters

### Fn\_46: Multi-function Analog output Meter Selection 0 - 3

- 0: Output freq.(Fn\_06 max) : 10Vdc / (Fn\_06)
- 1: Set frequency (Fn\_06 max): 10Vdc / (Fn\_06)
- 2: Output voltage (Vac) : 10Vdc / (Fn\_30)
- 3: DC voltage : (10Vdc / 450 Vdc: for 200V series)  
(10Vdc / 900 Vdc: for 400V series)

### Fn\_47: Meter Display Mode

- xxx0: Output Voltage display disable
- xxx1: Output Voltage Display enable
- xx0x: DC Voltage Display disable
- xx1x: DC Voltage Display enable
- x0xx: Output Current disable
- x1xx: Output Current enable (Meters)

Fn_48: Dynamic Braking, Priority Stopping, Speed Search and AVR Control
---

- |       |                            |
|-------|----------------------------|
| xxx0: | Enhanced braking capacity. |
|-------|----------------------------|
- |       |                           |
|-------|---------------------------|
| xxx1: | Standard braking capacity |
|-------|---------------------------|
- |       |   |
|-------|---|
| xx0x: | Stop key effective in remote control mode |
|-------|---|
- |       |   |
|-------|---|
| xx1x: | Stop key ineffective in remote control mode |
|-------|---|
- |       |   |
|-------|---|
| x0xx: | Speed search controlled by terminals on TM2 |
|-------|---|
- |       |  |
|-------|--|
| x1xx: | Speed search effective when T-verter start |
|-------|--|
- |       |                        |
|-------|------------------------|
| 0xxx: | AVR function effective |
|-------|------------------------|
- |       |                          |
|-------|--------------------------|
| 1xxx: | AVR function ineffective |
|-------|--------------------------|

Note:
-------

1. When selecting (Fn\_48) for enhanced braking capacity, the inertia of the load can be absorbed by using the output voltage adjustment for deceleration.
2. When selecting (Fn\_48) for stop Key effective in remote control, the “STOP” key on Keypad can be used for emergency stopping even when using the terminal 2 for remote control operation. (Stopping mode set by Fn\_44) The External switch must be turned OFF and ON again to re-start the T-verter.
3. When selecting (Fn\_48) Speed Search from Terminal 2, the Speed search will be effective if the multi-function inputs are used (Fn\_56) (Fn-57) (Fn\_58) (Fn\_59) (Fn\_60) otherwise, T-verter will start based on start frequency (Fn\_42)
4. Speed search will search from preset frequency during operation.
5. Please refer to Fn\_05 (V/F pattern) for AVR function.

Fn_49: Acceleration Time 2	0.1 ~ 3600 Sec.
----------------------------	-----------------

Fn_50: Deceleration Time 2	0.1 ~ 3600 Sec.
----------------------------	-----------------

**Fn\_51: Display Mode Selection**      1 ~ 5

The Display contents can be switched back and forth using the DSN  
FUN key either in the run mode or stop mode.

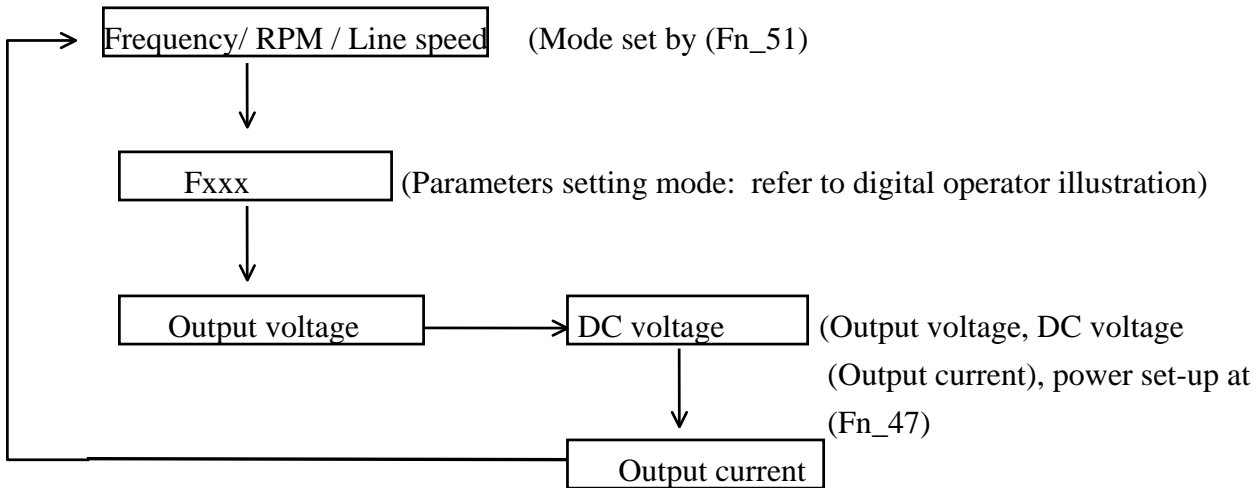

**Fn\_52: Line Speed Display**      1 ~ 0-9999

$$\text{(RPM)} = \frac{120}{\text{Fn}_{36}} \times \text{frequency}; \quad \text{Line speed} = \frac{\text{freq.}}{\text{Fn}_{06}} \times \text{Fn}_{52} \text{ (decimal digits decided by Fn}_{51}\text{)}$$

**Fn\_53: DC Braking Time**      0.1 ~ 0 to 25.5 Sec.

**Fn\_54: DC Braking Injection Frequency**      0.1 ~ 0.1 to 10 Hz

**Fn\_55: DC Braking level**      0.1 % ~ 0 to 20 %

**Fn\_56 ~ Fn\_58: Multifunction Inputs**

**Note:**

The application parameters in the Multifunction Input list are all assignable on TM2. Terminals (6) (7) and (8) are the designated application terminals for the following features.

<b>00</b> :	SP1 (Multi-speed 1) :	Please refer to (Fn_17)
<b>01</b> :	SP2 (Multi-speed 2) :	Please refer to (Fn_17)
<b>02</b> :	SP3 (Multi-speed 3) :	Please refer to (Fn_17)
<b>03</b> :	Jog operation	Please refer to (Fn_17)
<b>04</b> :	Accel. / Decel. Time selection	Please refer to (Fn_01)
<b>05</b> :	External Emergency Stop	
<b>06</b> :	External Base Block Command	
<b>07</b> :	Speed search :	Please refer to (Fn_48)
<b>08</b> :	Energy saving mode :	Please refer to (Fn_82)
<b>09</b> :	Control Signal Selection	
<b>10</b> :	Communication Control Mode Selection	
<b>11</b> :	Accel. / Decel. Prohibit	
<b>12</b> :	UP command	
<b>13</b> :	DOWN command	
<b>14</b> :	Sequence control :	Please refer to (Fn_17) (Fn_84) ~ (Fn_91)
<b>15</b> :	Master / Auxiliary speed selection :	Please refer to (Fn_11)
<b>16</b> :	(N/O - normal open contact) to (N/C - normal close contact)	

**Note:**

(Fn\_56) will be ineffective when Terminal 6 is used for 3-wire control There are 32 combinations that can be selected as above by terminals 6, 7, 8, (Fn\_56) (Fn\_57) (Fn\_58)

**05 External Emergency Stop**

As soon as external emergency stop signal is received, the T-verter will Decel. to a stop (regardless of the setting in (Fn\_44) the display will blink "E.S." After this signal is removed, either turns OFF and ON the RUN command again to reset. The in verter will restart from the start freq. If the Emergency stop signal is removed before the T-verter stops, T-verter will still execute the emergency stop.

**06 External Base Block Command**

The Base Block Command can be found in the Multifunction input assignment group (6), As soon as Base Block signal is applied, the T-verter output is shut off regardless of the setting in (Fn\_44) and the display will blink "b.b.". After the base block input is removed, either turn OFF and ON again run command, or to press the RUN key and the T-verter will restart from the start freq.

The Fault contact is controlled by Fn\_97:

When Fn\_97=0xxx Fault contact is not energized after external base block

When Fn\_97=1xxx Fault contact is energized after external base block



### 09 Control signal selection

Multi-input terminal OFF: Operation command/ Freq command is from digital operator or remote control (TM2), according to the setting of Fn\_10 / Fn\_11

Multi-input terminal ON: Operation command/ Freq command is from digital operator regardless of the setting of Fn\_10 / Fn\_11

### 10 Communication control mode selection

Multi-input terminal OFF: During communication, Inverter can receive Rnu/Freq signals from control unit (PC or PLC), Parameter can be changed by control unit, Run/Freq signals from Keypad and TM2 will be ineffective, Keypad can be used for displaying Voltage / Current / Frequency or emergency stop but can not be used for changed parameters

Multi-input terminal ON: During communication, The Rnu/Freq command is controlled by Inverter itself, Control unit (PC or PLC) is just for reading parameters.

### 11 Accel/Decel Prohibit

The T-verter will stop accelerating or decelerating when Accel. / Decel. Prohibit signal is activated. When the signal is removed, the T-verter continues accelerating or decelerating.

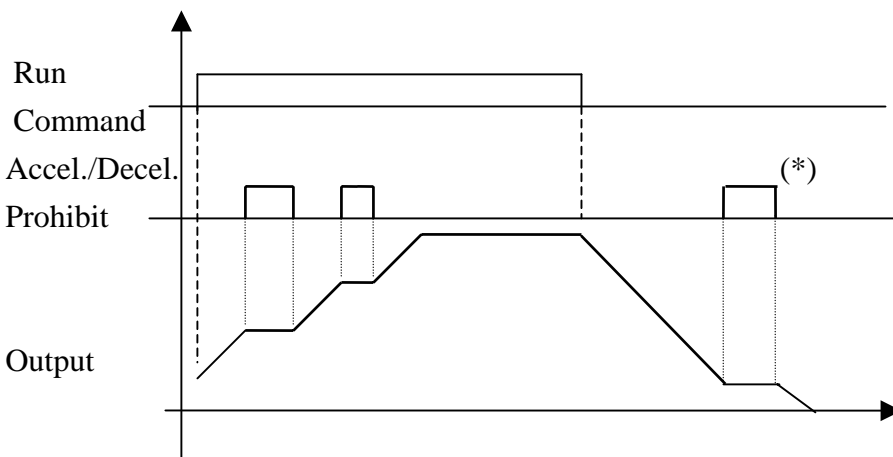

\*: When the “Run” command is off, the Accel and Decel prohibit command is inactive.

### 12 / 13 UP / DOWN command

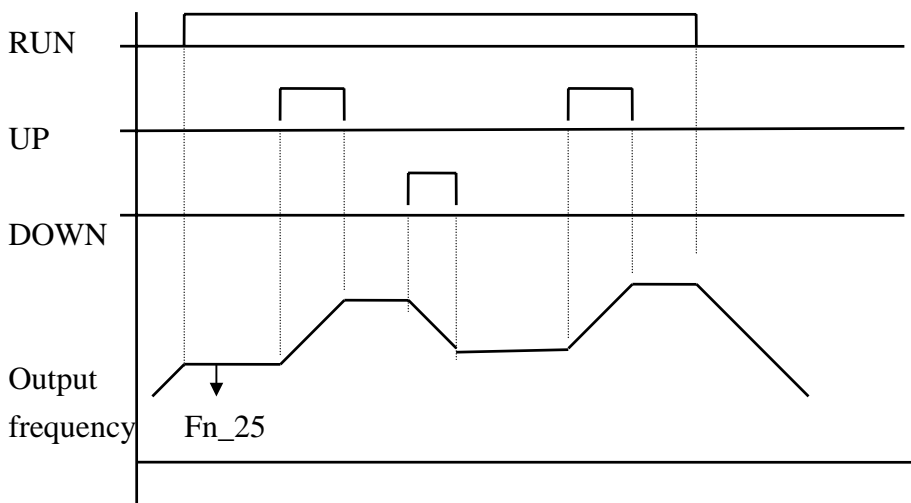

### Note:

To utilize the up and down function (Fn\_11) must be set to terminal control.

When using this function set (Fn\_03) to the (0xxx) position. The T-verter will accelerate to the target frequency set at (Fn\_25) after the designated terminal is turned on, the drive will remain at what ever speed it was at when the contact terminal was released.

When the (UP) or (DOWN) terminal is engaged, the T-verter starts accelerating or decelerating. When the UP or DOWN signal disappears, the T-verter will stay at the current frequency. Once the operating signal is off, the T-verter will decelerate to a stop or stop immediately (decided by Fn\_44), the operation frequency will be recorded in (Fn\_25)

Terminal UP or DOWN control is inactive during the stop mode. The target frequency must be changed at (Fn\_25) through the Keypad.

### Fn\_61: Multi-Function Output: Terminals 10 / 11

- 00: Run Mode
- 01: At Target Speed
- 02: Set Frequency (Fn\_08) +/- (Fn\_09)
- 03: Frequency Detection > (Fn\_08)
- 04: Frequency Detection < (Fn\_08)
- 05: Over Current Detection
- 06: Change contact status From (NO) to (NC)

Fn\_65: Skip Frequency 1      0.01 Hz ~ 0 to 400 Hz

Fn\_66: Skip Frequency 2      0.01 Hz ~ 0 to 400 Hz

Fn\_67: Skip Frequency 3      0.01 Hz ~ 0 to 400 Hz

Fn\_68: Frequency Band Width 0.01 Hz ~ 0 to 10 Hz

**Example:**

When (Fn\_65) is set at 10.0 Hz, (Fn\_66) is set at 20.0 Hz, (Fn\_67) is at 30.0 Hz, (Fn\_68) Skip bandwidth at 2.0 Hz

The skip freq. ranges are:     $10 \text{ Hz} \pm 2 \text{ Hz} = 8 - 12 \text{ Hz}$   
    $20 \text{ Hz} \pm 2 \text{ Hz} = 18 - 22 \text{ Hz}$   
    $30 \text{ Hz} \pm 2 \text{ Hz} = 28 - 32 \text{ Hz}$

Fn\_69: Electronic Overload Protection

- xxx0: Electronic thermal motor protection activated
- xxx1: Electronic thermal motor protection deactivated
- xx0x: Electronic thermal characteristics in accordance with standard motor
- xx1x: Electronic thermal characteristics in accordance with special motor
- x0xx: Motor protection OL: 103% continues, 150% for one minute
- x1xx: Motor protection OL: 113% continues, 123% for one minute
- 0xxx: Free run to stop after electronic thermal motor protection is energized
- 1xxx: Operation continued after electronic thermal motor protection is energized

Fn\_70: (Motor Rated Current) (-----)

**Note:**

1. You must enter the motors Rated nameplate current in function (Fn\_70) for proper thermal protection.

2. When the motors output current exceeds 103%, of the motors protective electronic thermal characteristics during the start operation. The T-verters protective (OL1) will allow operation of the drive for 150% of rated current for one minute before shutting the T-verters output off.

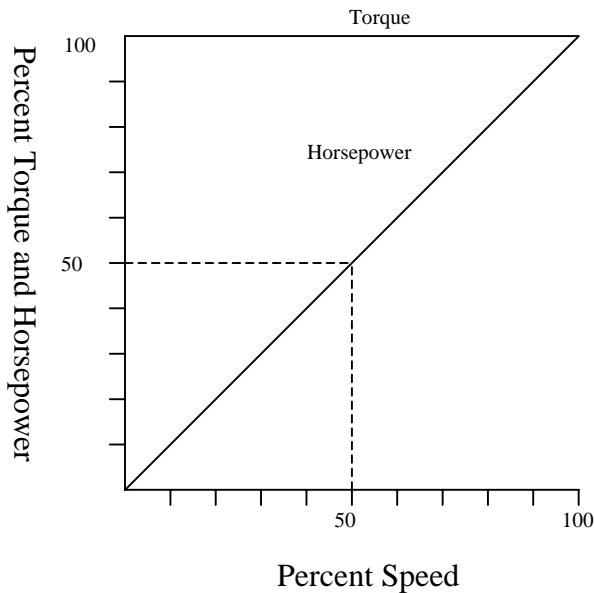

Constant Torque Loads:

With a constant torque load, the torque loading is not a function of the speed. This is a characteristic of traction drives, conveyors, positive displacement pumps, etc.

As the speed changes, the load torque will remain constant and the horsepower will change linearly with the speed.

**Note:**

To protect the motor under an HVAC load (Fan, Pump...etc.), when the motors output current exceeds 113%, of the motors protective electronic thermal characteristics during the start operation. The T-verters protective (OL1) will allow the drive to operate at 123% for one minute before shutting the T-verters output off.

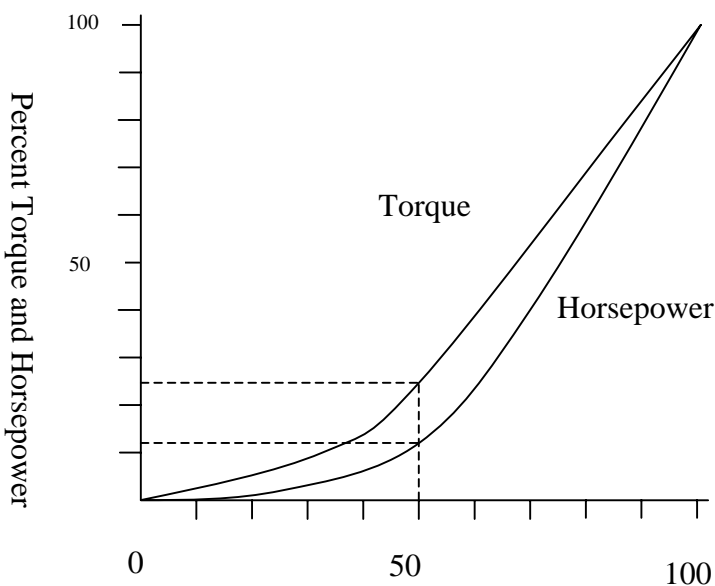

Variable Torque Loads:

With a variable torque load, torque loading is a function of the speed. This is a characteristic of centrifugal pumps, and certain types of fans and blowers. As the speed is increased, typically the torque will increase with the square of the speed and the horsepower will increase with the cube of the speed.

**Note:**

During operational conditions where the motor must run at low speeds, its important to pay attention to the motors capacity to dissipate heat, since most motors are designed to cool them selves at 60 Hz and full voltage, proper setup of the thermal functions should be observed.

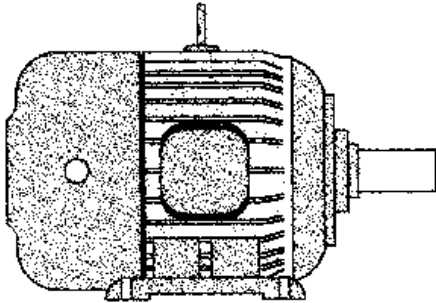

The motors ability to cool itself is dependent on its on board fan. Low speeds and high currents can reduce the life of the motor. Use the T-verters thermal protections and setup features to help with these types of situations.

When the electronic thermal motor protection is on in (Fn\_69) during an overload condition, the T-verter will continue running and while displaying “OL1” the blinking of the OL1 will continue until the running current is lower than 103% or 113% (depending on the setting in (Fn\_69).

The functions of the electronic thermal T-verter protection are as follows.

The T-verter will continue to run when the current is under 110%; if the T-verter continues above 110% the T-verter will time out proportionally to 150% at one minute.

In (Fn\_71) if the setting is (xxx0) after the electronic thermal T-verter protection is energized, the T-verter Base Block immediately shuts down the drive and starts to display “OL2”.

To re-start the T-verter, it is necessary to press the RESET key

In (Fn\_71) if the setting is (xxx1) after the electronic thermal T-verter protection is energized, the T-verter will continue to run and display a blinking “OL2” until the current is lower than 110% of the rating.

**Setup & D-Rating**

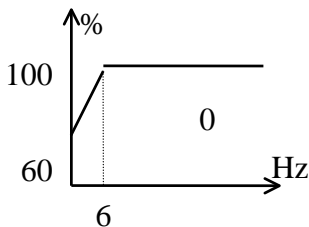

FIG. 1

(Fn\_69) is (xx1x)

Special Motor

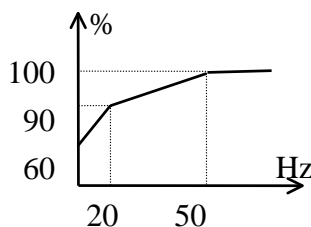

FIG. 2

(Fn\_69) is (xx0x)

(Fn\_05) is (0-8)

50 Hz Standard Motor

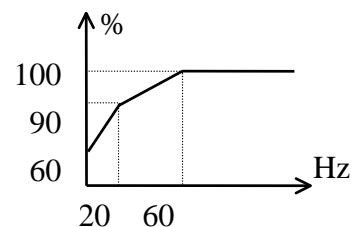
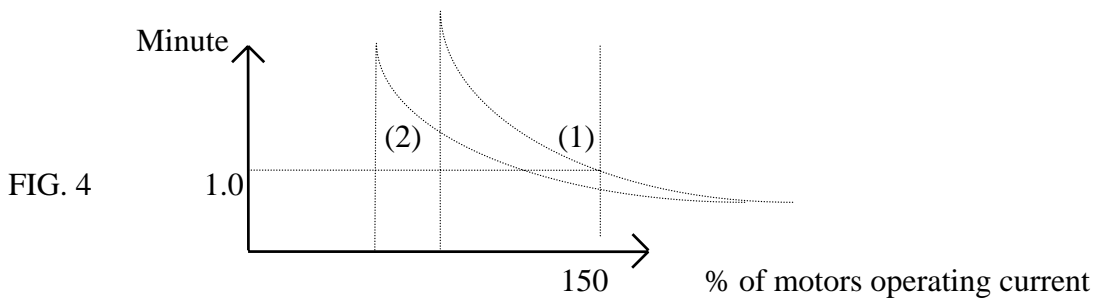

FIG. 3

(Fn\_69) is (xx0x)

(Fn\_05) is (9-17)

60 Hz Standard Motor



Fn\_71: Torque Boost

- xxx0: Free run to stop after electronic thermal T-verter protection is energized
- xxx1: Operation continued after electronic thermal T-verter protection is energized
- x0xx: Torque Boost enable
- x1xx: Torque Boost disable

Fn\_72: Torque compensation gain: 0.1 to 10 %

Note:

In (Fn\_71) When using the setting (x1xx) Both Auto and Manual torque boost are inactive.

When using the setting (x0xx) the T-verter adjusts the torque boost by automatically according to the T-verter's output current.

When using the setting (x1xx) the Torque boost is adjusted according to the settings in V/F pattern (Fn\_05) and (Fn\_72)

Fn\_75: Motors No Load Current- - - -

Fn\_76: Motor rated slip: 0 - 6 Hz

Fn\_77: Over Torque Control

- xxx0: Over-torque detection disable
- xxx1: Over-torque detection enable
- xx0x: Enable only if at set freq.
- xx1x: Enable during operation
- x0xx: Operation continued after over-torque is detected
- x1xx: Free run to stop after over-torque is detected

Fn\_78: Over Torque Detection Level: 30 - 200 %

Fn\_79: Over Torque Detection Time: 0 - 25 sec

Note:

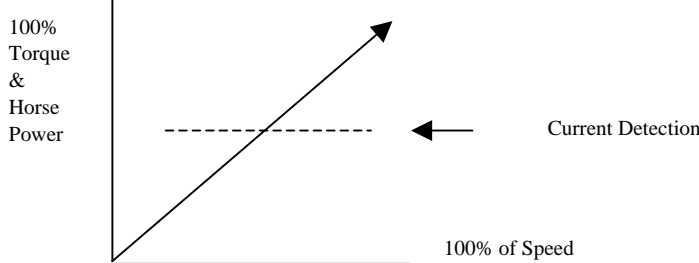

1. Definition of the over torque feature: the output current (rated current is 100%) remains above over torque detection level (Fn\_78) during over torque detection time (Fn\_79).
2. (Fn\_77) is set to (x0xx) When over torque occurs, the T-verter continues running and display the blinking “OL3” light until the output current is lower than the (Fn\_78) setting.  
(Fn\_77) is set to (x1xx) When over torque occurs, the T-verters base blocks immediately and the display blinks “OL3”. To re-start the drive, it is necessary to press RESET key.
3. When (Fn\_61) (Fn\_62) or (Fn63) (multi-function output terminal control) is set to 05, the multi-function output provides an over torque detection signal. The over torque detection output signal is available only if (Fn\_77) is set to (xxx1)

Fn\_80: S-Curve Set-up: Time (1) Acceleration & Deceleration: 0 to 4 Sec.

Fn\_81: S-Curve Set-up: Time (1) or (2) Acceleration & Deceleration:0 to 4 Sec.

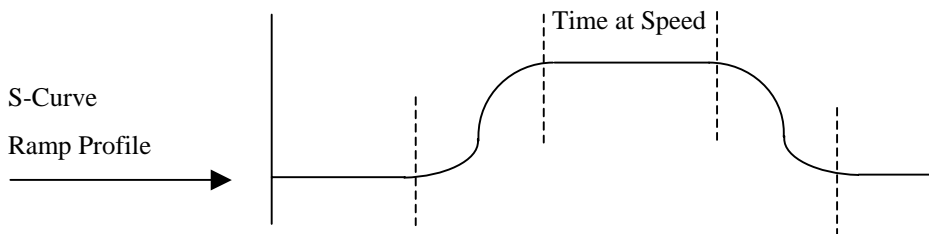

Formula for Calculating Acceleration and Deceleration Time.

$$\text{Accel. Time} = (\text{Fn}_{01}) \text{ or } (\text{Fn}_{49}) \times \frac{\text{Preset Frequency}}{60 \text{ Hz}}$$

$$\text{Decel. Time} = (\text{Fn}_{02}) \text{ or } (\text{Fn}_{50}) \times \frac{\text{Preset Frequency}}{60 \text{ Hz}}$$

**Note:**

1. Accel & Decel S-Curves ( 1 or 2 ) can be selected by using the multifunctional input terminals along with the programming of (Fn\_56) (Fn\_57) or (Fn\_58 to (4).
2. The S-Curve function is disabled when (Fn\_80) (Fn\_81) is set to (0).
3. The S-Curve ramp pattern will reflect the ramp pattern above if the S-Curve time in (Fn\_80) (Fn\_81) is greater than (0).
4. Total Actual Accel and Decel times are calculated by adding the actual Accel and Decel with the S-Curve time.

**Fn\_82: Energy Savings:**

**xx00:** Energy saving disable

**xx01:** Energy saving controlled by multi-input terminals using pre-set speed functions

**Fn\_83: Energy saving gain: 0 - 100 %**

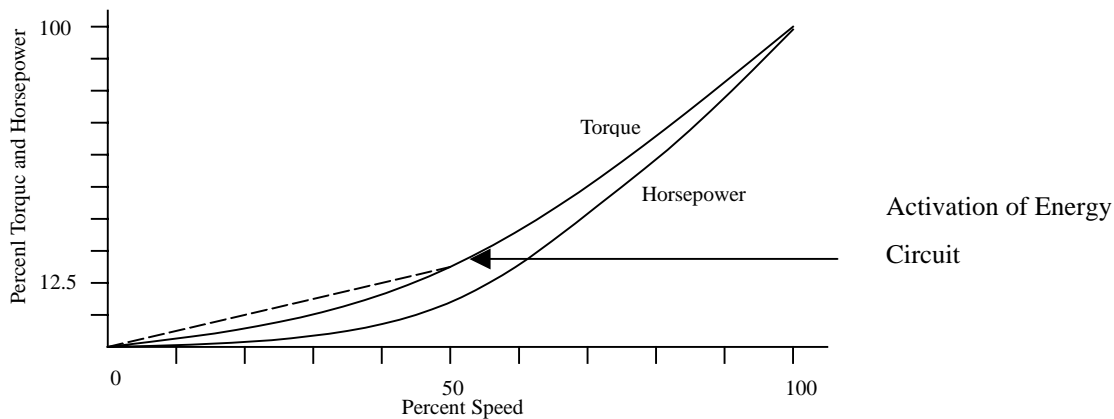

1. This function can be applied to Fans or Pumps that have loads with high starting inertia. In these types of applications where the load is heavy during start-up but tapers off to a variable torque type load at some point in the ramp curve, using function (Fn\_83) to adjust the suitable gain (voltage level) at the target speed will reduce the V/Hz ratio saving energy.
2. The Energy saving function is available only if (Fn\_56) (Fn\_57) or (Fn\_58) (multi-function input) are set to (08) or (24).
3. When (Fn\_82) is set to (xx01) and (Fn\_56) (Fn\_57) or (Fn\_58) are set to (08) When the multi-function input terminal is turned ON, the output voltage will decrease gradually to the previous output voltage x (Fn\_83). When the input terminal is turned off, the output voltage will increase to the previous voltage gradually.



Remark:

The speed of above mentioned voltage ramps up and down is the same manner as is does when using speed search.

**Fn\_84: Sequence Control**

- xxx0:** Process Timer Disabled
- xxx1:** Process Timer Enabled
- xx0x:** Set Frequency output after process Timer ends count
- xx1x:** Zero Speed output after Timer ends count
- x1xx:** Process Sequence Auto repeat

SP1	SP2	SP3	T-verter frequency
OFF	OFF	OFF	Set by external signal or digital operator control1(1)
ON	OFF	OFF	Frequency of Fn17 (2)
OFF	ON	OFF	Frequency of Fn18 (3)
OFF	OFF	ON	Frequency of Fn19 (4)
ON	OFF	ON	Frequency of Fn20 (5)
ON	OFF	ON	Frequency of Fn21 (6)
OFF	ON	ON	Frequency of Fn22 (7)
ON	ON	ON	Frequency of Fn23 (8)

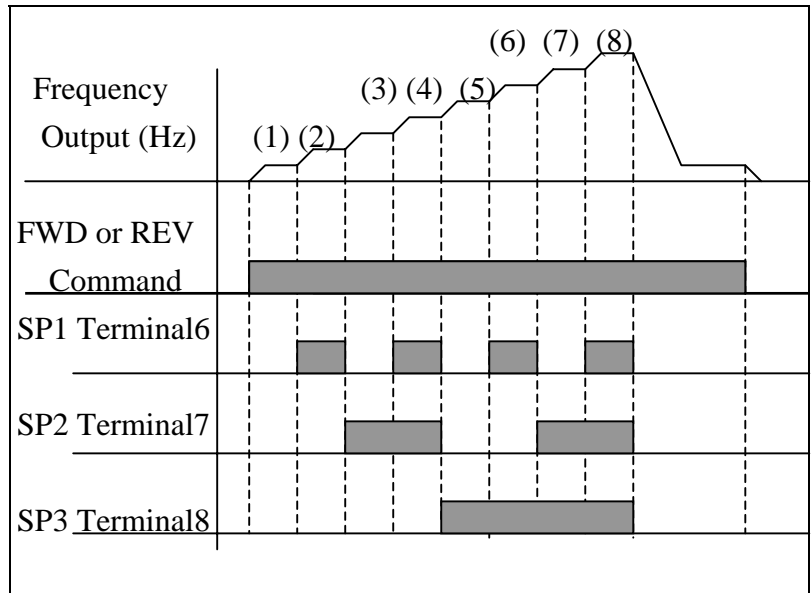

Note:

1. When Fn\_84=xxx0, T-verter will be operate under multi-speed frequency when Fn\_56~Fn\_58 is set to 0~2 and multi-function input terminal is on.

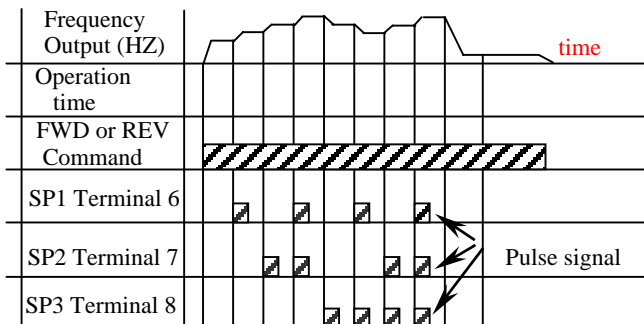

For Process Sequence Control use the Process Timers and the Preset Speed functions. (Fn\_85) Through (Fn\_91) (Fn\_17) Through (Fn\_23)

Note:

2. If Fn\_84=xxx1, Fn\_56~Fn\_58=0~2 or 16~18 and pulse signal is received on multi-function input, T-verter will run at a certain to time (set by Fn\_85~Fn\_91) at a certain frequency \*set by Fn\_17~Fn\_23) then return to frequency set by keypad or external VR or(Fn\_84=xx0x) or jump back to zero speed(Fn\_84=xx1x).

3. If Fn\_84=x0x1,Fn\_56~Fn\_58=14 or 30 and pulse signal is received on multi-function input, T-verter will operate in process1=>2=>3=>4....sequence till all process time is over then returns to frequency set by keypad or external VR or jump back to zero speed(Fn\_84=xx1x or xx0x), VR (Fn\_84=xx0x) or jump back to zero speed(Fn\_84=xx1x).

4. If Fn\_84=x1x1, Fn\_56~Fn\_58=14 or 30 the sequence control cycle will repeat, operate in process1=>2=>3=>4...1=>2=>3=>4.. till zero stop command input the T-verter will stop.

Fn_85:	Process Timer:	1	0.1 sec.	~	0 to 3600 sec.
Fn_86:	Process Timer:	2	0.1 sec.	~	0 to 3600 sec.
Fn_87:	Process Timer:	3	0.1 sec.	~	0 to 3600 sec.
Fn_88:	Process Timer:	4	0.1 sec.	~	0 to 3600 sec.
Fn_89:	Process Timer:	5	0.1 sec.	~	0 to 3600 sec.
Fn_90:	Process Timer:	6	0.1 sec.	~	0 to 3600 sec.
Fn_91:	Process Timer:	7	0.1 sec.	~	0 to 3600 sec.

Fn_92:	Vibration Control Time:	1 ~ 100
--------	-------------------------	---------

Fn_93:	Vibration prevention gain:	0 - 100 %
--------	----------------------------	-----------

Fn_94:	Vibration prevention bias:	0 - 30 %
--------	----------------------------	----------

**Note:**

1. Adjusting (Fn\_92) (unit: 2ms) to 1/4 of machine's vibration cycle can provide the optimal performance.

2. Adjusting (Fn\_93) according to the amplitude of vibration can reduce vibration to a minimum.

Fn_95:	Factory Adjustments only:
--------	---------------------------

Fn_96:	Factory Adjustments only:
--------	---------------------------

**Fn\_97: Fault Control Set-up**

<b>xxx0:</b>	Fault contact is not energized during auto restart operation
<b>xxx1:</b>	Fault contact is energized during auto restart operation
<b>xx0x:</b>	Fault contact is not energized during momentary power loss detection
<b>xx1x:</b>	Fault contact is energized during momentary power loss detection
<b>x0xx:</b>	Fault contact is not energized after external emergency stop signal is received
<b>x1xx:</b>	Fault contact is energized after external emergency stop signal is received
<b>0xxx:</b>	Fault contact is not energized during external base-block
<b>1xxx:</b>	Fault contact is energized during external base-block

**Fn\_98: Fault Contact Set-up**

<b>xxx0:</b>	Fault contact is not energized after over-torque (OL3) is detected
<b>xxx1:</b>	Fault contact is energized after over-torque (OL3) is detected
<b>xx0x:</b>	Fault contact is not energized after electronic over-load (OL1) is activated
<b>xx1x:</b>	Fault contact is energized after electronic over-load (OL1) is activated
<b>x0xx:</b>	Fault contact is normal open (N/O)
<b>x1xx:</b>	Fault contact is normal close (N/C)
<b>0xxx:</b>	Fault contact is not energized after electronic over-load (OL2) is activated
<b>1xxx:</b>	Fault contact is energized after electronic over-load (OL2) is activated

**Note:**

When (Fn\_97) is set to (xxx0), During the auto restart operation the fault contact will not be energized until (Fn\_35 (auto restart times) decreases to 0. (OL1 / OL2 / OL3)

**Fn\_100: Communications I.D. Number: 1 ~ 32**

**Fn\_101: Baud rate of Communication: (bps)**

<b>0:</b>	=	4800
<b>1:</b>	=	9600
<b>2:</b>	=	19200
<b>3:</b>	=	38400

Fn\_102: Communication Parameters:

xxx0:	1 stop bit
x0xx:	Without parity
xxx1:	2 stop bits
x1xx:	With parity
xx0x:	Even parity
0xxx:	8 bits data
xx1x:	Odd parity
1xxx:	7 bit data

Note:

To use RS-485 the RS-485 interface card is required.

- a. For one to one control: Using a PC, PLC or some sort of control device to control one drive set (Fn-100) to (1)
- b. When controlling multiple T-verters using a PC, PLC or some sort of control device to control multiple drives set up (Fn\_100) according to the number of drives you are controlling. Each number will identify and be used as the address for the drives identification and parameter set-up and change.
- c. There can be up to 32 T-verters that can be controlled simultaneously using the communication interface function.
- d. If the PC sends the code 33 to the T-verters, all linked T-verters (up to 32) can be controlled simultaneously all receiving the same signal or parameter change.

To use RS-232 Communications the RS-232 interface card is required:

- a. For one to one control: Using a PC, PLC or some sort of control device to control one drive set (Fn-100) to (1)
- b. An ASCII CODE is used for N2 communication.

- c: (Fn\_10) and (Fn\_11) will be ineffective for T-verter operation and frequency control while in the communication mode.
- d: The frequency signals upper and lower limits are controlled by (Fn\_06) (Fn\_07) while in the communication mode.
- e: The PC will request data from the T-verter automatically to obtain information on the (STATUS\_LED, Vac, Vpn, Iac, Freq., RPM)
- f: The T-verter will confirm the validity of the new parameters when set by the PC.
- g: Please refer to the communications manual for the RS-232 and RS-485-for detail function and protocol information.

**Fn\_123: Return Drive to Factory Settings:**

- (1111) Returns Drive to Factory settings for 60Hz operation:
- (1110) Returns Drive to Factory settings for 50Hz operation:

**Fn\_124: CPU Software Version:**

**FN-125: Fault Log: Last 3 Faults**

In order to simplify any troubleshooting, The T-verter memorizes the last three fault codes automatically in its EEPROM memory. Pressing the up & down arrows on the key-pad to review the faults recorded.

**Sample:**

- 1. (LV-C) The first fault code (the newest) is low voltage
- 2. (OC-d) Over current during deceleration
- 3. (- - -) No fault recorded (only two faults occurred)

## Failure Codes:

Faults, which cannot be reset by manual operation:

Fault Code	Content	Probable Cause	What to do
CPF	CPU software error	1. High electronic noise	1. Install RC type suppresser on all contactor / brake coils
EPR	EEPROM error	1. EEPROM is damaged	1. Change EEPROM
- OV -	Over Voltage in stop mode	1. Detection circuit is damaged	1. Notify your supplier to check
- LV -	Low Voltage in stop mode	1. Input voltage is too low 2. Current limit resistor (R1) or fuse burned out - 400V series T-verter 3. Detection circuit is damaged	1. Correct input voltage 2. Change current limit resistor or fuse 3. Notify your supplier to check
- OH -	Heat sink Over-Heat in stop mode	1. Detection circuit is damaged 2. Ambient temperature is too high or ventilation is poor	1. Notify your supplier to check 2. Lower ambient temperature or improve ventilation
OH1 *	Braking resistor overload	1. Decel. Time is too short 2. Frequent run/stop operation 3. too much load	1. Prolong Decel. Time. 2. Prolong run/stop cycle 3. Set Fn_44 to xx0x and increase resistance of braking resistor

Note:

When the braking resistor is overloaded during deceleration, the T-verter will stop braking and displays OH1. When the heat is dissipated, the OH1 will disappear and the T-verter will start braking again.

Faults, which can be auto-reset or reset by manual operation

Fault Code	Content	Probable Cause	What to do
OC-S	Over Current during Starting	<ol style="list-style-type: none"> <li>1. Motor is short circuited</li> <li>2. Motor has ground fault</li> <li>3. T-verter transistor module is damaged</li> </ol>	<ol style="list-style-type: none"> <li>1. Check and fix motor</li> <li>2. Remove the grounding point</li> <li>3. Change transistor module</li> </ol>
OC-A	Over Current during Accel.	<ol style="list-style-type: none"> <li>1. Accel. Time is set too short</li> <li>2. Inappropriate V/F pattern selection</li> <li>3. Motor capacity exceeds the T-verter rating</li> </ol>	<ol style="list-style-type: none"> <li>1. Extend Accel. Time</li> <li>2. Select the optimum V/F pattern</li> <li>3. Select a larger HP T-verter</li> </ol>
OC-C	Over Current during Constant speed	<ol style="list-style-type: none"> <li>1. Load changes excessively</li> <li>2. Input voltage fluctuates excessively</li> </ol>	<ol style="list-style-type: none"> <li>1. Check load condition</li> <li>2. Install a reactor between power supply and T-verter</li> </ol>
OC-d	Over Current during Decel.	<ol style="list-style-type: none"> <li>1. Decel. Time is set too short</li> </ol>	<ol style="list-style-type: none"> <li>1. Extend Decel. Time</li> </ol>
OC-b	Over Current during Braking	<ol style="list-style-type: none"> <li>1. Braking freq. is set too high</li> <li>2. Braking voltage is set too high</li> <li>3. Braking time is set too long</li> </ol>	<ol style="list-style-type: none"> <li>1. Reduce braking freq.</li> <li>2. Lower braking voltage</li> <li>3. Shorten braking time</li> </ol>
OV-C	Over Voltage during Constant speed	<ol style="list-style-type: none"> <li>1. Decel. Time is set too short or load inertia is too high</li> <li>2. Input voltage fluctuates</li> </ol>	<ol style="list-style-type: none"> <li>1. Extend Decel. Time</li> <li>2. Set Fn_48 = xxx0</li> <li>3. Add external braking resistor or module</li> <li>4. Install a reactor between power supply and T-verter</li> <li>5. Select a larger HP T-verter</li> </ol>
LV-C	Low Voltage during Constant speed	<ol style="list-style-type: none"> <li>1. Input voltage is too low</li> <li>2. Input voltage fluctuates excessively</li> </ol>	<ol style="list-style-type: none"> <li>1. Correct input voltage or extend Fn_31</li> <li>2. Extend Accel. Time</li> <li>3. Select a larger HP T-verter</li> <li>4. Install a reactor between power supply and T-verter</li> </ol>

OH-C	Over Heat during Constant speed	1. Load is too high 2. Ambient temperature is too high or ventilation is poor	1. Investigate load condition 2. Select a larger HP T-verter 3. Lower ambient temperature or improve ventilation
OH1	Braking resistor overload	1. Decel. Time is too short 2. Frequent run/stop operation 3. Load is too high	1. Prolong Decel. Time. 2. Prolong run/stop cycle 3. Set Fn_44 to xx0x and increase resistance of braking resistor

Faults, which can be reset by manual operation, but cannot be auto reset

Fault Code	Content	Probable Cause	What to do
- OC-	Over current during stop mode	1. Detecting circuit failure 2. CT Signal cable Failure	1. Send T-verter back for repairing
OL1	Motor overload	1. Load is too high 2. Inappropriate V/F pattern selection 3. Incorrect Fn_69, Fn_70 setting	1. Select a larger HP T-verter 2. Select optimum V/F pattern 3. Select correct Fn_69 & Fn_70 setting
OL2	T-verter overload	1. Load is too high 2. Inappropriate V/F pattern selection	1. Select a larger HP T-verter 2. Select optimum V/F pattern
OL3	Over-torque	1. Load is too high 2. Inappropriate V/F pattern selection 3. Fn_78, Fn_79 are set too low	1. Select a larger HP T-verter 2. Select optimum V/F pattern 3. Select appropriate Fn_78 & Fn_79 settings



## Special Condition Indication

Fault Code	Content	Illustration
STP0	Zero speed stop	<p>1. Fn_11 = 0 or 3, Fn_07 &lt;0.1 Hz, and setting freq.&lt;0.1 Hz; Fn_11 = 1 or 23, Fn_07 &lt;(Fn_06/100), and setting freq. &lt;0.1 Hz</p>
STP1	Direct start disable	<p>1. Power switched on while remote RUN switched on (Fn_10) Direct start is prohibited (Fn_16= xxx1). T-verter can not be started and will display STP1.(Refer to Fn_16) T-verter can be started directly when Fn_16 = xxx0</p>
STP2	Emergency stop command by STOP key	<p>1. Emergency stop via digital operator in remote control mode (Fn_10 = 1) by pressing STOP key (Fn_48 = xx0x). Once STOP key is pressed during operation, T-verter will stop according to the setting of Fn_44 and display STP2. T-verter will not restart until power is turned off and on again. 2. If the T-verter is under communications control and Fn_48 = xx0x, Once STOP key is pressed, T-verter will stop according to the setting of Fn_44 and display STP2. T-verter will not restart until computer sends Stop command followed by a RUN command 3. STOP key can not be used for emergency stop when Fn_48=xx1x.</p>
E.S.	Emergency stop command by remote control	<p>1. Emergency stop via remote control mode (multi-function input terminals), The T-verter will decelerate to stop and display E.S.</p>
b.b.	External base-block	<p>External abnormal signal base-blocks T-verter via multi-function input terminals (please refer to Fn_56-60)</p>

Digital Operator Operation Failure Indication:

Fault Code	Content	Probable Cause	What to do
LOC	Parameter / freq. / REV direction is locked	<ol style="list-style-type: none"> <li>1. Try to change parameter /freq. when Fn_04 = xxx1 or xx1x</li> <li>2. Try to run in REV direction when Fn_03 = x1xx</li> </ol>	<ol style="list-style-type: none"> <li>1. Set Fn_04 = xxx0 or xx0x</li> <li>2. Set Fn_03 = x0xx</li> </ol>
Err1	Operation error	<ol style="list-style-type: none"> <li>1. Try to change freq. by pressing <math>\wedge</math> or <math>\vee</math> when Fn_11 &gt; 0</li> <li>2. Try to change Fn_124</li> <li>3. Try to change functions which cannot be changed during operation</li> </ol>	<ol style="list-style-type: none"> <li>1. Set Fn_11 = 0</li> <li>2. Fn_124 (CPU version) cannot be changed</li> <li>3. Change those functions in stop mode</li> </ol>
Err2	Setting error	<ol style="list-style-type: none"> <li>1. Fn_07 is in the range of <math>Fn_{65} \pm Fn_{68}</math>, <math>Fn_{66} \pm Fn_{68}</math> or <math>Fn_{67} \pm Fn_{68}</math></li> <li>2. <math>Fn_{06} \leq Fn_{07}</math></li> <li>3. <math>Fn_{70} \leq Fn_{75}</math></li> <li>4. <math>Fn_{27} \geq Fn_{28}</math></li> </ol>	<ol style="list-style-type: none"> <li>1. Adjust Fn_65 - Fn_68 or Fn_07 setting</li> <li>2. <math>Fn_{06} &gt; Fn_{07}</math></li> <li>3. <math>Fn_{70} &gt; Fn_{75}</math></li> <li>4. <math>Fn_{27} &lt; Fn_{28}</math></li> </ol>
Err3	Setting error	<ol style="list-style-type: none"> <li>1. V/F curve is set too steep when Fn_05= 18</li> <li>2. Analog freq. signal is set too steep</li> </ol>	<ol style="list-style-type: none"> <li>1. <math>(Fn_{38} - Fn_{40}) / (Fn_{37} - Fn_{39}) \leq 65</math>, <math>(Fn_{40} - Fn_{41}) / (Fn_{39} - 0.1) \leq 65</math></li> </ol>
Err4	Setting error	<ol style="list-style-type: none"> <li>1. Incorrect settings of Fn_37 - Fn_41</li> </ol>	<ol style="list-style-type: none"> <li>1. <math>Fn_{37} &gt; Fn_{39} &gt; 0.1</math> Hz <math>Fn_{38} \geq Fn_{40} \geq Fn_{41}</math></li> </ol>
Err5	Parameters setting error	<ol style="list-style-type: none"> <li>1. Under disable condition</li> <li>2. Amend Fn-101 or Fn_102 during communication</li> </ol>	<ol style="list-style-type: none"> <li>1. Set enable before communication Fn_101, Fn_102 should be amended before communication.</li> </ol>
Err6	Communication error	<ol style="list-style-type: none"> <li>1. Connection error</li> <li>2. Improper parameters</li> <li>3. Checksum error</li> <li>4. Agreement error</li> </ol>	<ol style="list-style-type: none"> <li>1. Investigate connection</li> <li>2. Check Fn_101, Fn_102</li> <li>3. Check communication agreement</li> <li>4. Check communication</li> </ol>
Err7	Parameter setting error	<ol style="list-style-type: none"> <li>1. Attempt to change Fn_00 or Fn_96</li> <li>2. The value in Fn_96 is far from the value of detected voltage</li> </ol>	<ol style="list-style-type: none"> <li>1. Refer to 2.3 "Changing control boards"</li> <li>2. Check PN voltage circuit</li> </ol>

## Maintenance Section:

This T-verter requires almost no routine checks. It will function efficiently and its normal operation lifetime will be longer if it is kept clean, cool and dry.

Especially check for tightness of electrical connections, discoloration or other signs of over-heating. ***During service inspection, turn off the AC main circuit power and wait for the charging indicator LED 101 to extinguish ( or at least 10 minutes) before touching any circuit components. Failure to adhere to this warning could result in serious or lethal injuries.***

- (1) Clean up internal dust and dirt
- (2) Check for tightness of electrical connection.
- (3) Do Mega test
  - (a) Remove all connection wires from the complete unit when doing Mega test.
  - (b) Mega test only can be applied on main circuit.

**NOTE!!** Never do Mega test on control circuit.

The insulation resistance of DC500V tester should be more than 5M ohm.

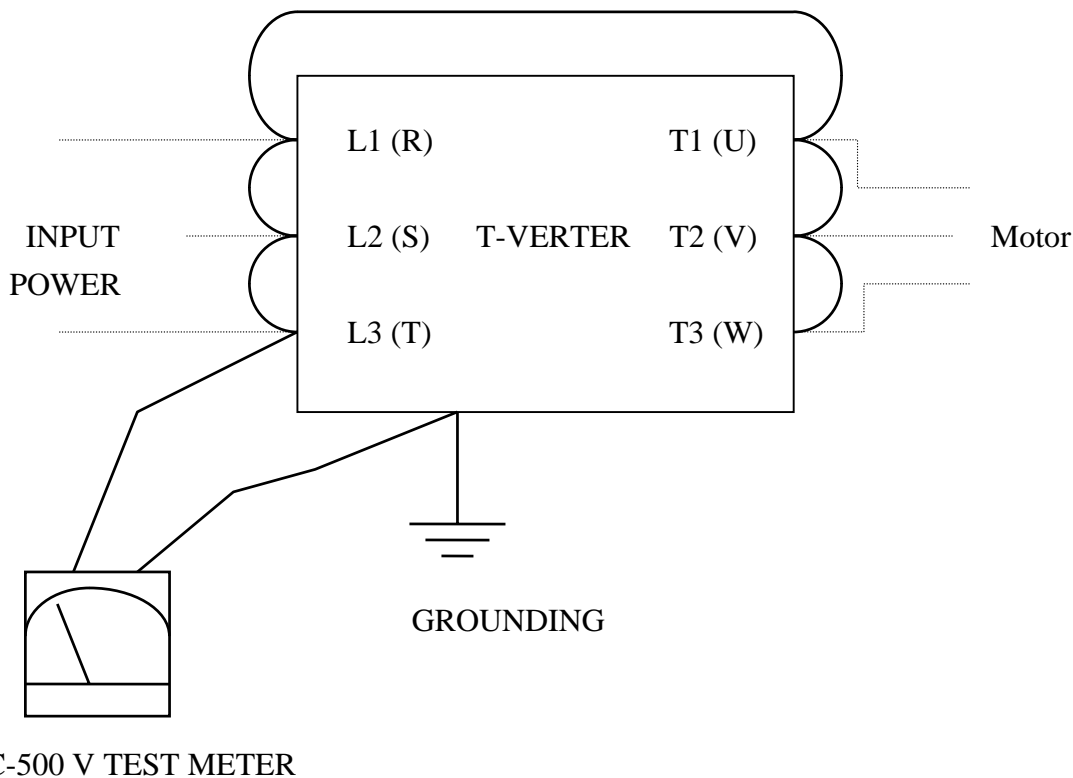

## COMPATIBILITY (EMC) filters:

Today all modern PWM variable speed drives, use fast switching power devices to achieve high efficiency and reduce motor noise. This results in electromagnetic interference (EMI) and radio frequency interference (RFI). For operational reasons the interference may need to be suppressed.

### EC DIRECTIVES

This T-verter is able to comply with the EC Directives 89/336/EEC on limits to EMI and RFI with the use of an optional filter. Independent testing has demonstrated compliance to the following standards when the optional filters are used.

### EMI Emission

EN61800-3, +A11: First Env. (ClassB) Table9,10.

Second Env. (ClassA) Table11,12.

200 Volt Class 2P5 ~ 203 are compliant with class B filters

400 Volt Class 401 ~ 405 are compliant with class B filters

400 Volt Class 408 ~ 430 are compliant with class A filters

### EMS Immunity Compliant

EN 50082-2 1995: CLASS A

### LVD Safety Compliant

EN 50178 1997

## FILTERING SELECTION

MODEL #	RATING	T-VERTER MODEL
B9810140	1 $\phi$ 220~240V/10A	N2-2P5/201-H
B9812047	1 $\phi$ 220~240V/20A	N2-202-H
B9812048	1 $\phi$ 220~240V/20A	N2-203-H
B9810102	3 $\phi$ 380~480V/10A	N2-401/402-H3
B9810103	3 $\phi$ 380~480V/10A	N2-403/405-H3
B9901153	3 $\phi$ 380~480V/20A	N2-408/410-H3
B9901154	3 $\phi$ 380~480V/48A	N2-415/420/425/430-H3

Interconnection diagrams for filters N2-200 series and 400 series interconnection

N2 200V Single Phase

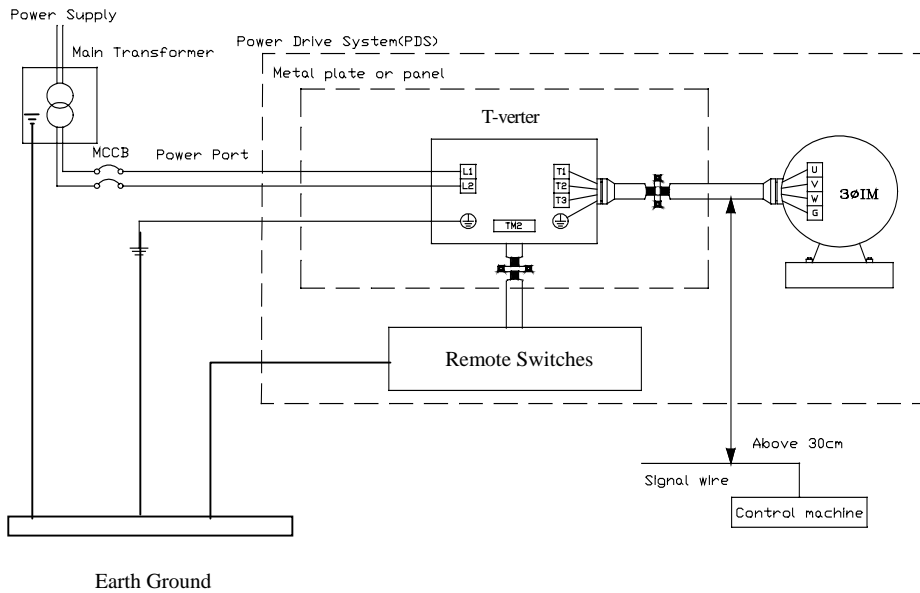

N2 200V / 400V Three Phase

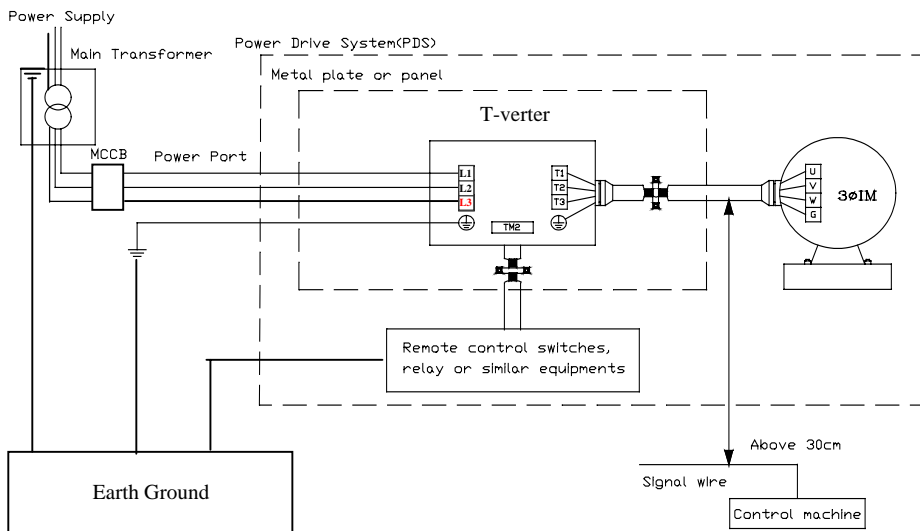

## ADDITIONAL PRECAUTIONS TO LIMIT EMI AND RFI

### Earth

#### For T-verters:

In any single low-impedance earth point or where busbar is required in order to put to earth directly or independently for varied circuit. The T-verter itself must be put to earth independently. No other equipment should share the earth connection of the T-verter (except the motor). All circuits have to be connected to external earth through copper bars.

Note: The system needs to be checked from time to time to ensure well connection to earth ground

#### For Induction Motors:

For electrical safety reasons, motors must connect to earth ground with a cable even if the motor is fixed on a metal plate. The best way is to use green line 4-core motor cable to connect between the frame of the motor and the earth ground of the T-verter. Please avoid putting the motor to earth ground via busbar.

#### For Control Circuit:

If the control circuit of T-verter links to any control switches, relays or other similar equipment, be sure the screened control line is put to earth ground on only one end.

#### For Shielding System:

In order to have a very low HF-impedance shielded cable with, a metal clamp and special adapters are required and the paint on the surface of metal has to be removed.

#### Shielding:

- 2.1 The T-verter will emit EMI noise via the connection cable; therefore, all motor cables, control cables and signal cables must be shielded unless the length of the cable is less than 1 meter.
- 2.2 The shielded motor cable must be put to the earth ground on both ends, the shorter the cable the better to reduce the stray inductance and capacitance effect.

### 3. Segregation

3.1 All signal cable and control cable must be separated from un-shielded or protected motor cable and unfiltered power lines. The distance should be more than 30 cm. The control cable and power cables should be put perfectly vertically when those two cable have to cross each other.

#### **WARNING**

EMI filter can be used only in 3 phase supplies, which are nominally balanced with respect to earth. Never apply EMI filter in a grounded delta supply system.

## Dimensions

### ● T-VERTER:

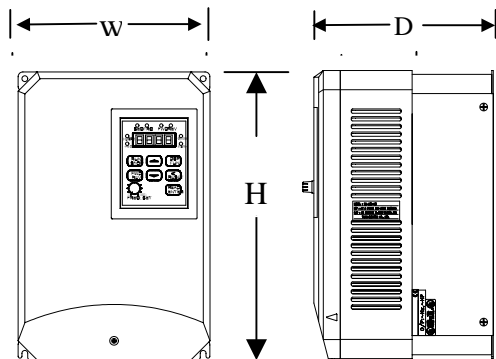

#### N2-200V IP20 Model

Units: Millimeter

Horse Power	1/2	1	2	3	5	7.5	10	15	20	30
Dimensions (W)x(H)x(D)	107x162x140		149x184x158	185x215x167		200x300x199		250x400x240		
Mounting Dim. (W)x(H)	96x150		138x174	174x205		186x286		236x385		

#### N2-400V IP20 Model

Units: Millimeter

Horse Power	1	2	3	5	7.5	10	15	20	30
Dimension. (W)x(H)x(D)	149x184x158		185x215x167		200x300x199		250x400x240		
Mounting Dim. (W)x(H)	138x174		174x205		186x286		236x385		

#### N2-200V IP65/NEMA4 Model

Units: Millimeter

Horse Power	1/2	1	2	3	5	7.5	10
Dimensions (W)x(H)x(D)	200x240x143			230x300x211.5		313x430x269	
Mounting Dim. (W)x(H)	180x225			210x275		258x415	

#### N2-400V IP65/NEMA4 Model

Units: Millimeter

Horse Power	1	2	3	5	7.5	10
Dimension. (W)x(H)x(D)	230x300x211.5				313x430x269	
Mounting Dim. (W)x(H)	210x275				258x415	



● **DIGITAL OPERATOR REMOTE CABLE (NW300X) for N2-2P5~205, N2-401~405**

1. Contents:

(1) Plastic housing for digital

operator:

① front side

③ rear side

(2) Remote cable: ④

NW3001 (1m)

NW3002 (2m)

NW3003 (3m)

(3) Remote cable adapter ⑤

(4) Accessory screws ⑥, ⑧

(5) Digital operator ②

NDOP-01

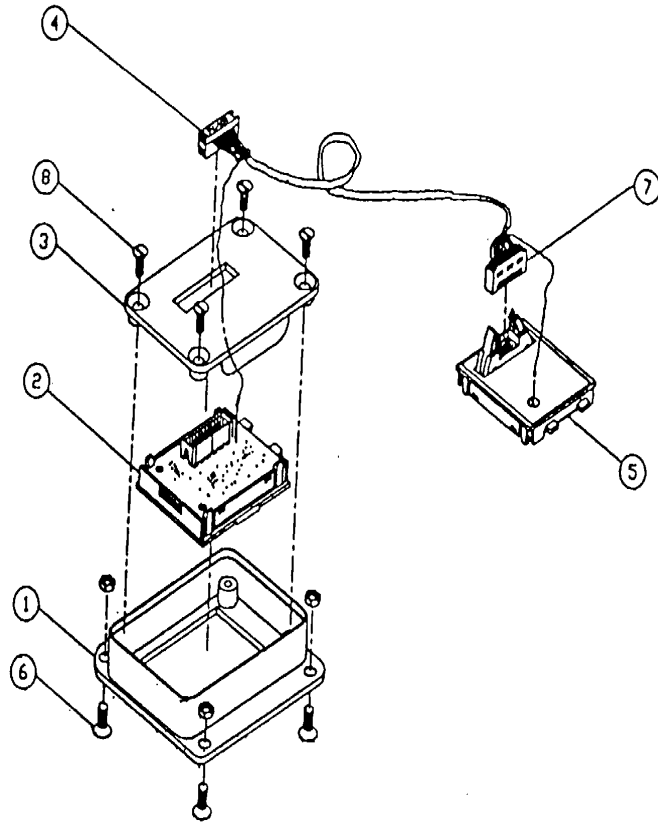

2. Installation:

(1) Turn off the power, make sure the T-verter power indicator (LED101) is off.

(2) Remove digital operator ② and grounding wires (PE) from T-verter.

(3) Put the digital operator ② into plastic housing ①, ③, then use screw 8 to assemble the housing as shown above.

(4) Put the remote cable adapter ⑤ into the T-verter.

(5) Connect terminal ④ of remote cable to adapter ⑤, and connect the grounding wire as well.

(6) Connect the other side terminal ⑦ of remote cable to adapter ⑤, and connect the grounding wire as well.

(7) Use accessory screws ⑥, to fix the remote operator to the panel.

(8) To avoid interference, proper grounding on T-verter enclosure is necessary. (grounding resistance must be less than 100  $\Omega$ , diameter of grounding wire must be bigger than 2mm<sup>2</sup>)

**NDOP-01 Mounting dimensions unit: mm**

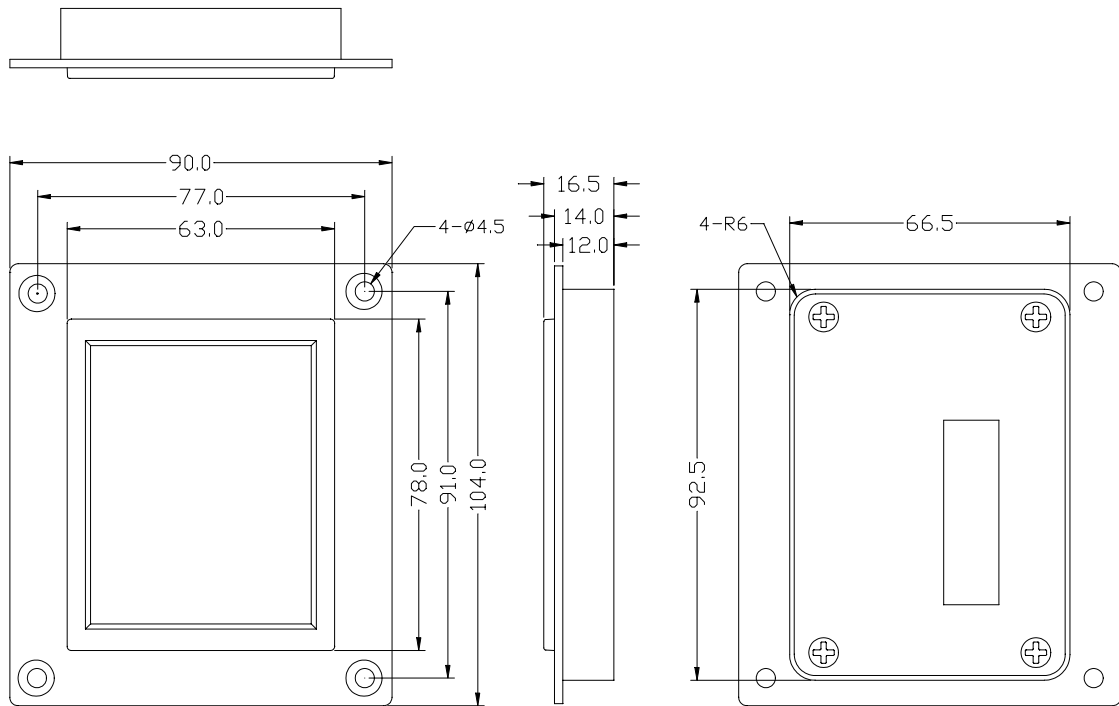

● **DIGITAL OPERATOR REMOTE CABLE (NW300XA) for N2-208~230,N2-408~430**

1. Contents:

- (1) Remote cable ②
  - NW3001A (1m)
  - NW3002A (2m)
  - NW3003A (3m)
- (2) Remote cable adapter ③
- (3) Digital operator ①
  - NDOP-02
- (4) Accessory screw ④

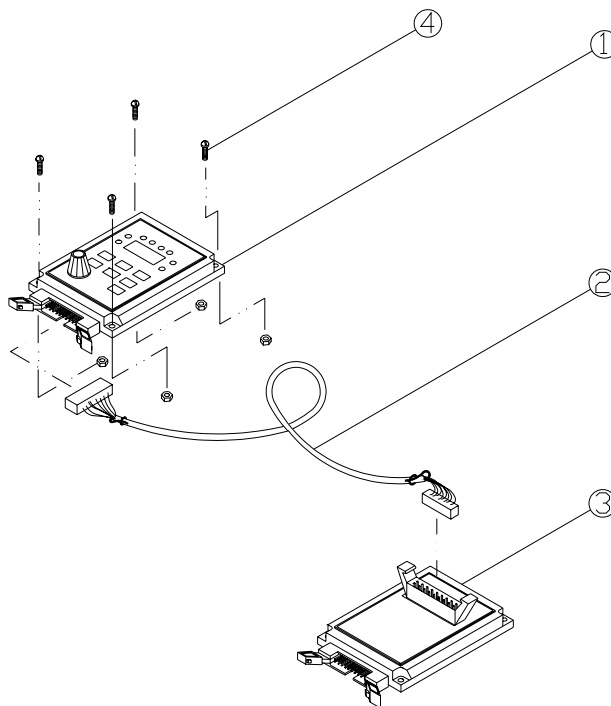

## 2. Installation:

- (1) Turn off the power, make sure the T-verter power indicator (LED101) is off.
- (2) Remove digital operator ① from the T-verter.
- (3) Put the remote cable adapter ③ into the T-verter.
- (4) Connect both side of the remote cable ② .
- (5) Use accessory screws ④ , to fix the digital operator ① to the panel.

### NDOP-02 Mounting dimensions unit: mm

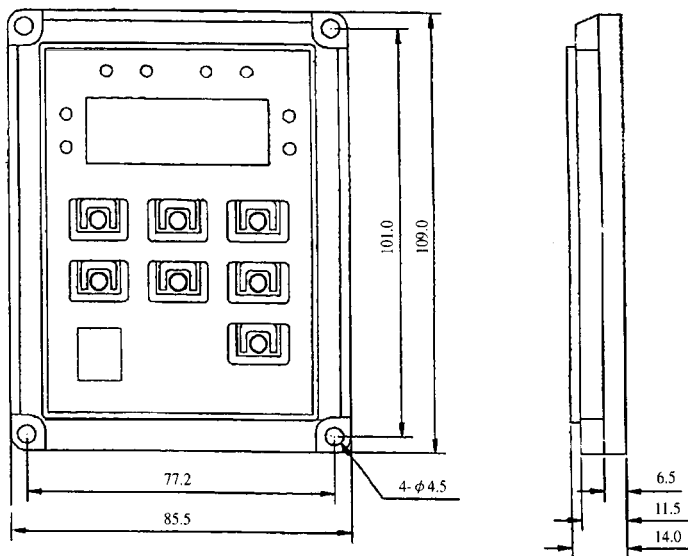

## Braking Resister and AC Reactors

MODEL	Built in Braking Transistor	Built in Braking Resistor	Braking Torque	Braking Resistor Code. No.	AC REACTOR	
					CURRENT (A)	Inductance(mH)
N2-2P5			20%	BRN2-201	2.5	4.2
N2-201			20%	BRN2-201	5.0	2.1
N2-202			20%	BRN2-202	10.0	1.1
N2-203			20%	BRN2-203	15.0	0.71
N2-205			20%	BRN2-205	20.0	0.53
N2-208			20%	BRN2-208	30.0	0.35
N2-210			20%	BRN2-210	40.0	0.265
N2-215			20%		60.0	0.18
N2-220			20%		80.0	0.13
N2-230			20%		120.0	0.09
N2-401			20%	BRN2-401	2.5	8.4
N2-402			20%	BRN2-402	5.0	4.2
N2-403			20%	BRN2-403	7.5	3.6
N2-405			20%	BRN2-405	10.0	2.2
N2-408			20%	BRN2-408	15.0	1.42
N2-410			20%	BRN2-410	20.0	1.06
N2-415			20%		30.0	0.7
N2-420			20%		40.0	0.53
N2-430			20%		60.0	0.36

: as standard,    : as optional.

### DC REACTOR

MODEL	Current (A)	Inductance (mH)
N2-215	55	0.67
N2-220	73	0.50
N2-230	109	0.33
N2-415	29	2.6
N2-420	38	1.9
N2-430	57	1.3

When using the DC REACTOR. remove the command bar between P1 & P , then wire the DC REACTOR to the two terminals.

## Braking Unit Specification

Applicable Inverter voltage		200V ~ 240V	380V ~ 480V
Braking unit model		TBU-230	TBU-430
Output Characteristics	One set max Applicable Motor Output KW (HP)	22KW (30HP)	22KW (30HP)
	Rated Discharge Current (A)	20	15
	Max Discharge Current (A)	60	40
	Braking Start Voltage (VDC)	DC325/358/374/390V 3±V	DC618/651/716/748/781V 6±V
Power Supply	Inverter Input Voltage	50/60Hz 200 ~ 240VAC	50/60Hz 380 ~ 480VAC
	Inverter DC BUS Voltage	243 ~ 400 VDC	460 ~ 800VDC
Protective Function	Overheat	Thermostat (with contact output)	
	Power Charge Indication	Charge lamp stays ON until bus voltage drops below 50VDC	
Environment Conditions	Location	Indoor (Protected from corrosive gases and dust)	
	Ambient Temperature	- 10 ~ + 40	
	Storage Temperature	- 20 ~ + 70	
	Humidity	0 ~ 95%RH (non-condensing)	
	Vibration	1G less than 20Hz ; up to 0.3G at 20 ~ 50Hz	
	Enclosure	IP20	
	Safety level	CE/UL/cUL	
	Installation	Screw mounted	
	Parallel connection	Parallel connection of braking unit is possible up to a maximum of 10 units	
	Dimension (W*H*D)	149 * 184 * 145.7 mm	

Loading time rate can be used below 10%ED (Max 10 seconds).

## Interconnection

Braking units have a master/slave selection connector, The master side selected prior to shipment, For using more than one parallel connected braking units, selected slave side for braking units second unit and above.

One braking unit is installation (One Inverter connected to one braking unit)

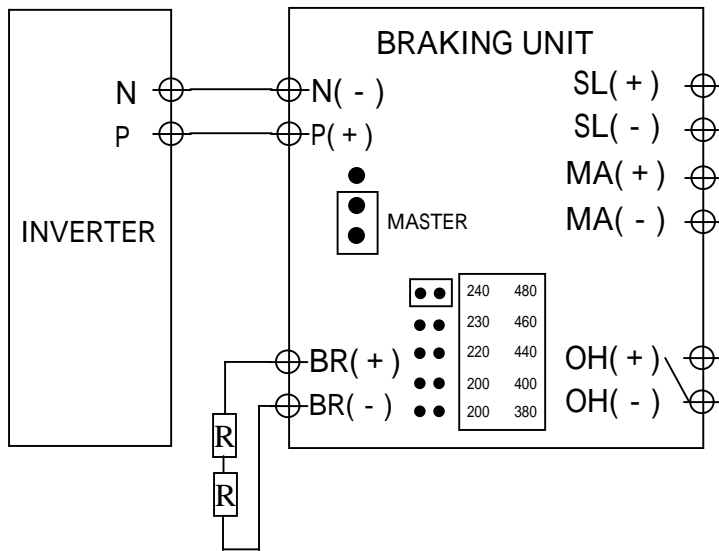

Parallel connection of braking units (One Inverter connected to two braking units and above)

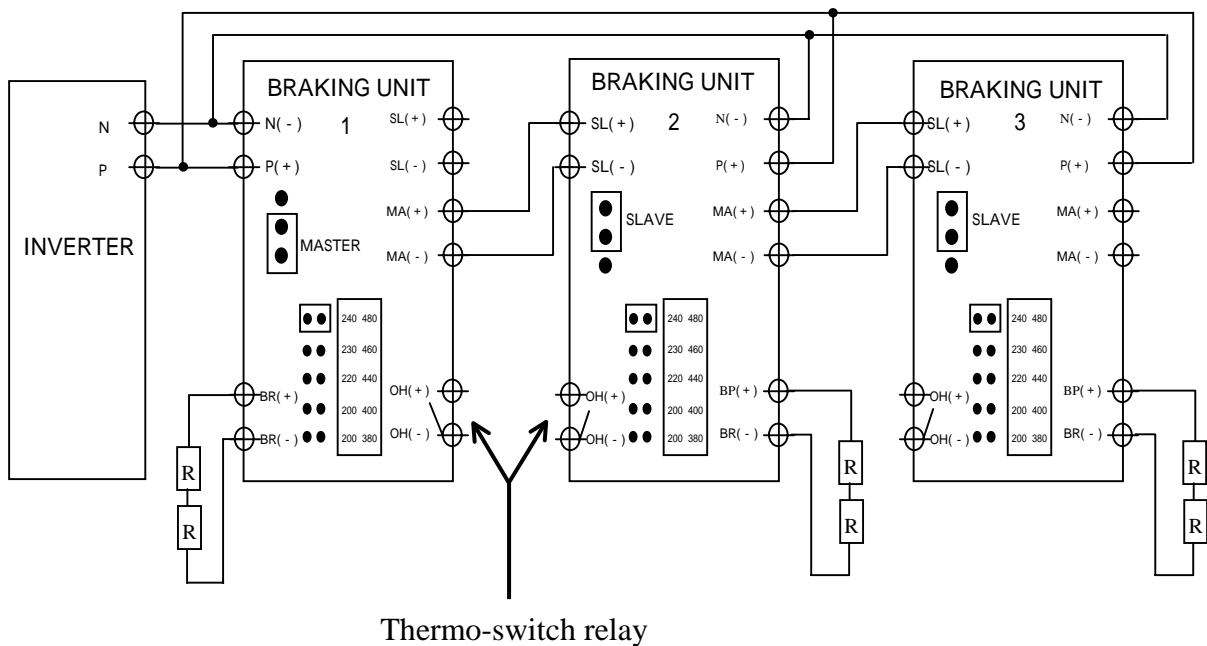

### Braking unit and braking resistor unit application list

Voltage	Max applicable motor capacity	Braking unit	Q'ty	Braking resistor specification	Q'ty	Min Ohm value	Approx. braking torque (10%ED)
220V	15HP	TBU-230	1	2400W 13.6	1	6.4	115%
	20HP	TBU-230	1	3600W 10	1	6.4	115%
	25HP	TBU-230	1	4800W 7.5	1	6.4	115%
	30HP	TBU-230	1	4800W 6.8	1	6.4	115%
440V	15HP	TBU-430	1	1500W 40	1	19.2	145%
	20HP	TBU-430	1	1500W 40	1	19.2	115%
	25HP	TBU-430	1	3000W 20	1	19.2	170%
	30HP	TBU-430	1	3000W 20	1	19.2	145%

# Trouble Shooting:

## (1) Motor doesn't work

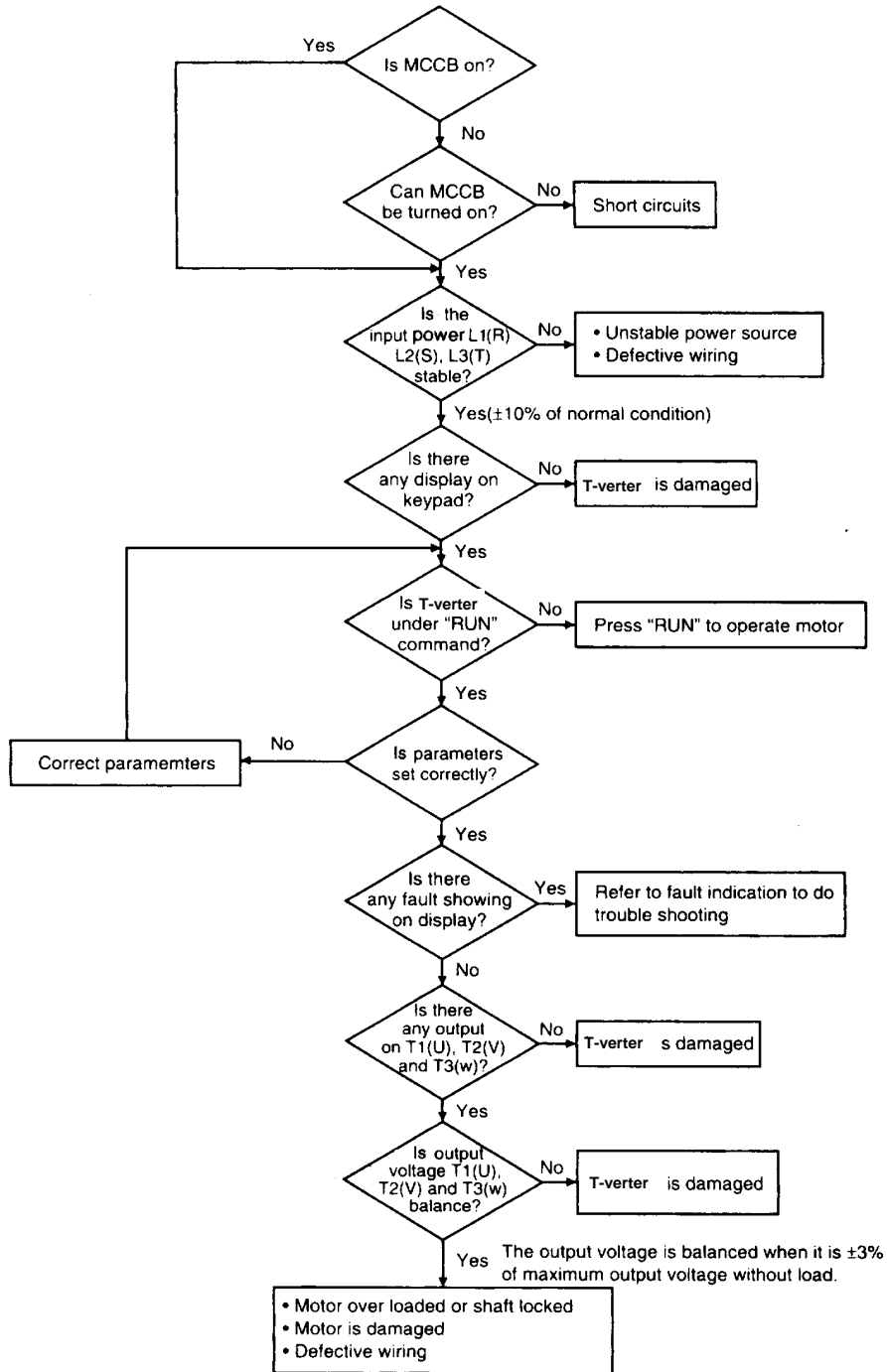



## (2) Motor Overheated

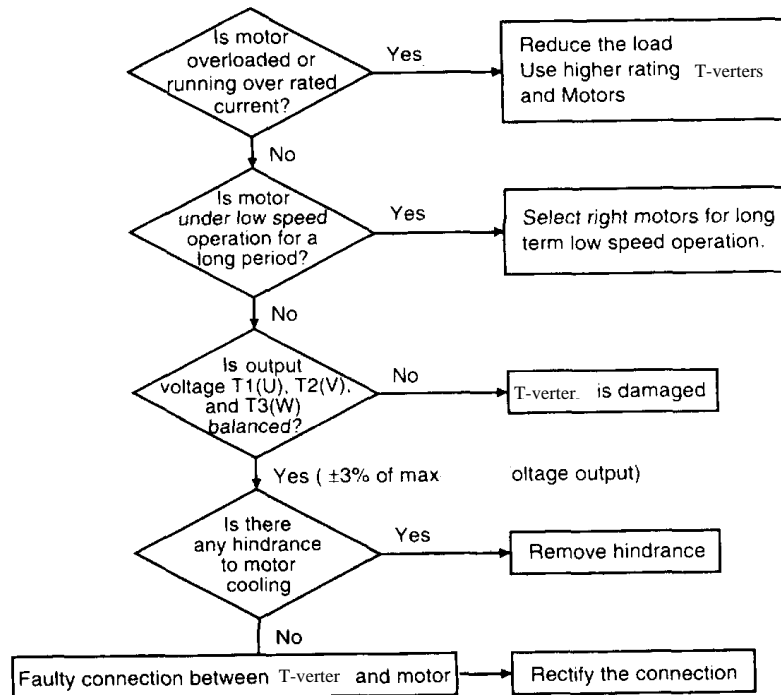

## (3) Motor does not run smoothly

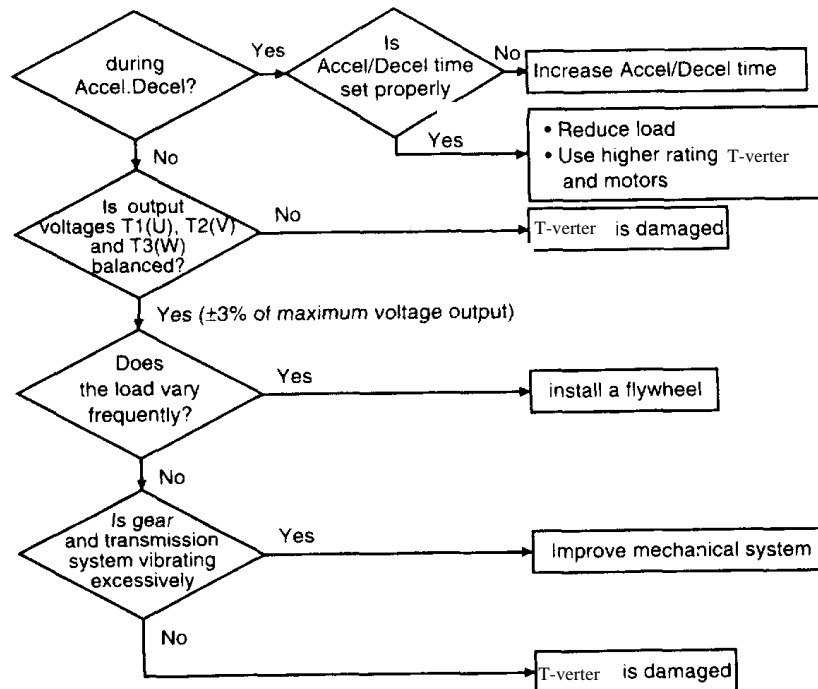

## FUNCTION LIST

Function	Setting	Function	Setting	Function	Setting	Function	Setting
Fn_00		Fn_32		Fn_64		Fn_96	
Fn_01		Fn_33		Fn_65		Fn_97	
Fn_02		Fn_34		Fn_66		Fn_98	
Fn_03		Fn_35		Fn_67		Fn_99	
Fn_04		Fn_36		Fn_68		Fn_100	
Fn_05		Fn_37		Fn_69		Fn_101	
Fn_06		Fn_38		Fn_70		Fn_102	
Fn_07		Fn_39		Fn_71		Fn_103	
Fn_08		Fn_40		Fn_72		Fn_104	
Fn_09		Fn_41		Fn_73		Fn_105	
Fn_10		Fn_42		Fn_74		Fn_106	
Fn_11		Fn_43		Fn_75		Fn_107	
Fn_12		Fn_44		Fn_76		Fn_108	
Fn_13		Fn_45		Fn_77		Fn_109	
Fn_14		Fn_46		Fn_78		Fn_110	
Fn_15		Fn_47		Fn_79		Fn_111	
Fn_16		Fn_48		Fn_80		Fn_112	
Fn_17		Fn_49		Fn_81		Fn_113	
Fn_18		Fn_50		Fn_82		Fn_114	
Fn_19		Fn_51		Fn_83		Fn_115	
Fn_20		Fn_52		Fn_84		Fn_116	
Fn_21		Fn_53		Fn_85		Fn_117	
Fn_22		Fn_54		Fn_86		Fn_118	
Fn_23		Fn_55		Fn_87		Fn_119	
Fn_24		Fn_56		Fn_88		Fn_120	
Fn_25		Fn_57		Fn_89		Fn_121	
Fn_26		Fn_58		Fn_90		Fn_122	
Fn_27		Fn_59		Fn_91		Fn_123	
Fn_28		Fn_60		Fn_92		Fn_124	
Fn_29		Fn_61		Fn_93		Fn_125	
Fn_30		Fn_62		Fn_94		Fn_125	
Fn_31		Fn_63		Fn_95		Fn_125	



**TECO Electric & Machinery Co., Ltd.**

**W** [www.teco.com.tw](http://www.teco.com.tw)

7<sup>th</sup>., 49, Wu Kong 6Rd. Wu-Ku  
Industrial Park, Taipei County 248,  
Taiwan, R.O.C.

Distributor

---

This manual may be modified when necessary because of improvement of the product, modification, or changes in specifications, This manual is subject to change without notice.

B3243-5 Ver:05 2003.09